



akdeio

forest products ground materials
import export
marketing industry and trade
LIMITED COMPANY



LUXURIOUS INTERIOR DOOR

akdeio

Forest Products Ground Materials Import Export Marketing Industry and Trade
LIMITED COMPANY

Mobile: +90 532 500 51 52 Mobile Company: +90 532 250 65 29

Phone: +90 212 111 11 11

Address: Atakent Mah. 243. Sk. No:6 Tema İstanbul Sitesi 7/B No:1 Halkalı / K.çekmece İstanbul / TÜRKİYE

Address: Khelvachauri, Akhalshehis Meurneoba Mah. 3-CU Sk. No: 26 Batumi / GEORGIA

Akdeio Orman Ürünleri Zemin Malzemeleri İthalat İhracat Pazarlama San. ve Tic. LTD. ŞTİ.



www.akdeio.com.tr

info@akdeio.com.tr

onder@akdeio.com.tr

[akdeio](https://www.facebook.com/akdeio)

[akdeioorman](https://www.instagram.com/akdeioorman)

beranet
Designed by Beranet



2021-1

KURUMSAL

Dortek markası 2003 yılında “Türkiye’nin ilk kapı markası” olarak kurulmuştur. Faaliyete başladığı günden bu yana Dortek markası patentli Monoblok teknolojisi ve Ultra-Viyole Lake uygulamalarında öncü olarak kapı teknolojileri ve kapı mimarisi alanlarında ilklere imza atmıştır. Faaliyete başladığı günden bu yana Dortek sürekli gelişen ürün gamı, üretim teknolojileri ve uygulama çözümleri ile kapı üretim sektöründe fark yaratmak ve kalite standartlarını bir üst seviyeye taşımayı hedeflemiştir. Bireysel pazarın yanı sıra proje danışmanlığı ve çözüm ortaklığı ile çeşitli mimari projelere özel mühendislik çözümleri ve kapı uygulamaları sunan Dortek 2021 yılına kadar bir çok mimari projenin (AVM, Okul, Hastane, Plaza, vb.) çelik kapı, yangın kapısı ve benzeri performans kapılarını tedarik etmiş ve çeşitli kapı sistemleri ve açılım çözümleriyle çözüm ortağı olmuştur.

Genel merkezi İstanbul’da olan Dortek’in 30.000m2 alana yayılmış olan üretim tesisleri Kastamonu’da bulunmaktadır. Ayda 30.000 adete kadar çıkabilen üretim kapasitesi ile Türkiye’nin, kapı üretiminde en büyük ve teknolojik anlamda en kapsamlı, üretim tesisi olma özelliğini taşımaktadır. Son teknoloji makinelerden oluşan makine parkında UV (Ultra Viole) Lake, PVC, doğal ve endüstriyel ahşap üretim hatları ile tam otomatik üretim yapılabilmektedir. Dortek markası, markayı ve teknolojileri hep bir adım ileriye taşımak için çalışan, alanında uzman Ar-Ge ekibi ve çeşitli projelere özel çözüm ortaklığı sunan proje satış ve geliştirme mühendislerinin yanı sıra Türkiye’nin ve dünya’nın çeşitli yerlerine yayılan bayileri ile bulunduğu her yerde hizmet anlayışında fark yaratarak kalite standartlarının belirleyicisi olmayı hedeflemektedir.

CORPORATE

Dortek is Turkey's first and leading door brand that specializes in architecture, design, construction, and sale of doors since 2003. Dortek became the pioneer brand in Turkey to use manufacturing technologies such as fully automatic production with UV (Ultra-Violet) Lacquer and Monoblock door production and has differentiated itself from competitors by achieving numerous breakthroughs in the field of door manufacturing. Dortek aims to make a difference in the field by improving their quality standards to a higher level with each of their innovations. Dortek's constantly developing product range and production technologies come with professional application solutions by their team of engineers who specialize in the application methods of different doors and problem resolution in large-scale construction projects. Dortek also offers specialized engineering support for various architectural projects of various scales. Their project consultancy varies from solution providers to individual market distribution and applications, in which Dortek provides a wide range of product lines such as steel doors, fire doors, and similar performance doors (Shopping Malls, Schools, Hospitals, Private Projects, etc.) and so on.

Dortek's headquarters are located in Istanbul, and their production facilities are built on 30.000m² in Kastamonu. Kastamonu Dortek Facilities have a production capacity of up to 30,000 units per month, which earns them the title of Turkey's largest and most technologically comprehensive production facility of door production. With a machine park with fully automatized UV (Ultra Violet) Lacquer, PVC, natural, and industrial wood production lines, the Kastamonu Dortek facility has state-of-the-art machinery and lines of production. Dortek brand provides service wherever it is located, with its R&D team, who are experts in their fields, and project sales and development engineers who always work to take the brand and technologies one step further, as well as project sales and development engineers that offer special solution partnerships for various projects, as well as dealers in various parts of Turkey and the world. Dortek aims to be the determinant of quality standards by making a difference in its understanding.



ADEN DENEYİMİ

Dortek, kapıda deneyimin adı ve sektörünün en kıdemlisi, kapı alanındaki bu deneyiminin yeni ürünlerini sizlere gururla sunar. Kolay erişim ve hızlı fabrika üretim-teslim ürünlerinize, Dortek kalite ve güvencesi ile ulaşabilmeniz için bu yeni seriyi yarattık. Kurumsal ihtiyaçlarınıza uygun, yeni çağın ve marketin getirdiği yeniliklere, sizin ve kurumunuzun adapte olabilmesi için tüm şartlar hazır.

Ulaşılabilirlik ve kaliteyi bir arada sunan yeni Aden serisinde, ihtiyaçlarınıza yönelik size özel hızlı ve güvenilir çözümler bulunmaktadır. Sunulan minimal ve zarif tasarımlardaki yaklaşım anlayışını, Aden deneyiminizin her aşamasında hissedeceksiniz.

Halihazırda onlarca başarılı model serisi bulunan Dortek, daha özel çözümleri, daha özel başlıklar altında topluyor ve yeni seriler topluluğunun ilkinin ortaya koyuyor. Mevcut model serilerimizden farklı olarak, yeni ürün tasarımlarından fazlası. Satın alma sürecinizin en başından en sonuna kadar, gelişen yeni ihtiyaçlarınıza cevap veren ve size özel olan, bambaşka bir deneyime hazır olun.

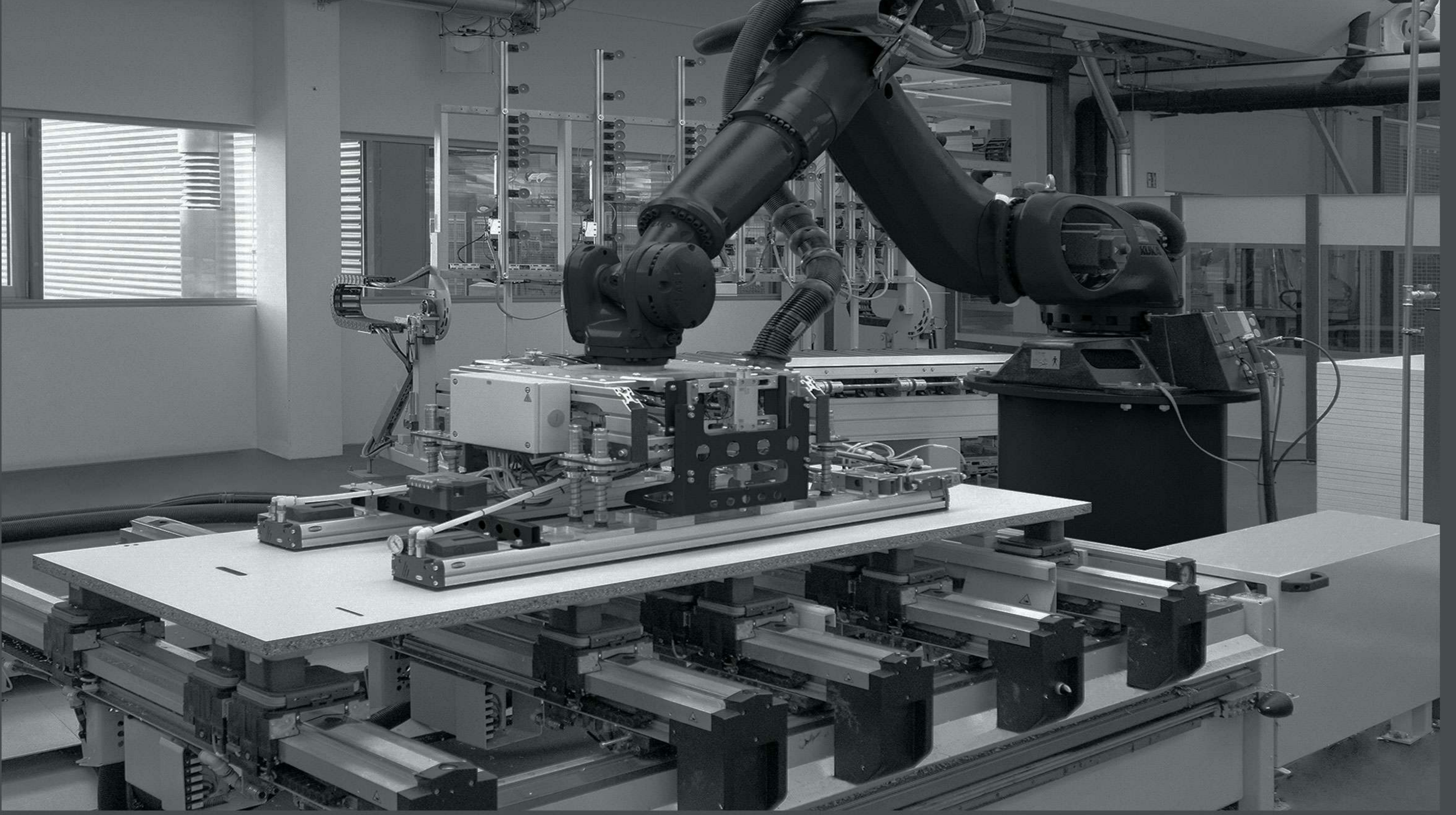

Size özel ihtiyaçlarınız, size özel çözümler gerektirir. Aden, sizlere pratikliği ve zarafeti, tavizsizce ve rekabetsiz olarak sunuyor.

ADEN EXPERIENCE

Dortek, which is the name of the experience in the door and the most senior in the sector, proudly presents you the new products of this experience in the door field. With Dortek quality and assurance, we created this new series for you to have easy access and fast factory production-delivery products. All the conditions are now ready for you and your institution to adapt to the innovations brought by the new era and the market in convenience with your corporate needs.

There are fast and reliable solutions tailored for your needs at Aden series which is offering attainableness and quality together. At every stage of your Aden experience, you will feel the approach of this proffered minimal and stylish designs.

Dortek, which already has tens of successful model series, collects special solutions under special confidential titles and reveals the first of the new series. More than just new product designs, unlike our current model lines. Get ready for a totally different experience that meets your needs and is completely unique to you, from the beginning to the end of the purchasing process.



Your specific needs require private solutions. Aden presents you the practicability and elegance with uncompromising and noncompetitive.

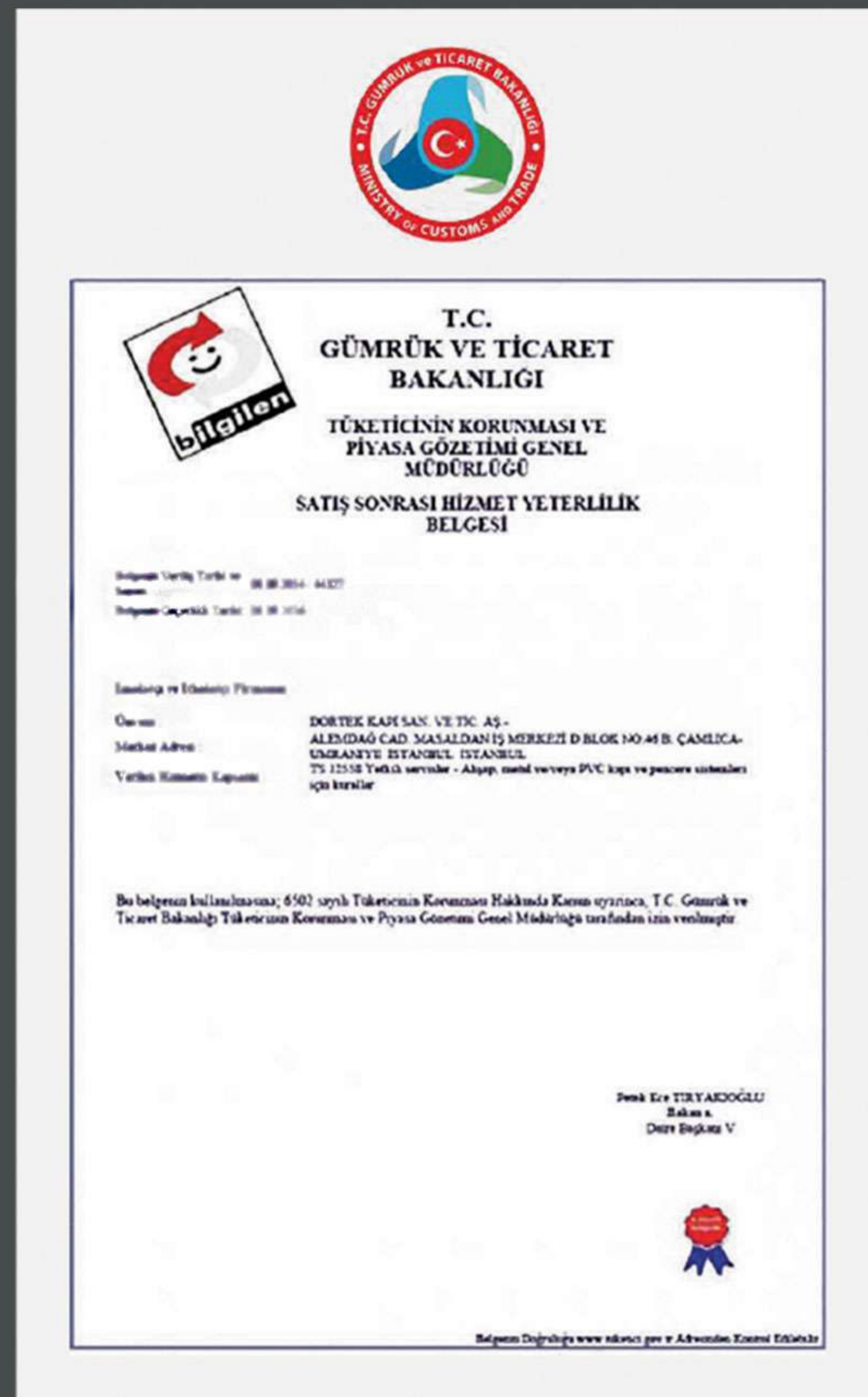



TÜRK STANDARTLARI ENSTİTÜSÜ
TSE-HYB
HİZMET YETERLİLİK BELGESİ

Belge No: 224478/2014
Bilgi Yolu Tarihi: 16.08.2014
Sıra/SıraNo/Tarih: 16.08.2014
Firmamız Adı: DORTEK KAPI SAN. VE TİC. A.Ş.
Firmamız Adres: ALEMDAĞ CAD. NO:48 ALEMDAĞ İŞ MERKEZİ D BLOK K:1 B ÇAMLIÇA ÖZMANSIYI
BETANBULUTURKYE
Hizmet Türü/Adresi: BARAJ YOLU İNÖZÜ MEVKİİ KASTAMONU/TÜRKİYE
Etiler No: 48020432787

Verilen Hizmetin Kapsamı:

1. TS 12467 (31.01.2012)YETKİLİ SERVİSLER - ANIŞAP VE/VEYA METAL MOBİLYA İÇİN - KURALLAR STANDARTINA UYGUN HİZMET VEREN KAPISAP, ANIŞAP VE/VEYA METAL MOBİLYAYA HİZMET VEREN
* DORTEK KAPI SAN. VE TİC. AŞ. YETKİLİ SERVİSİ (1079848)
(16.10.2011) (DORTEK) MARKALI
2. TS 12008 (19.03.2009)YETKİLİ SERVİSLER - ANIŞAP, METAL VE/VEYA PVC KAPI VE PENCERE SİSTEMLERİ İÇİN KURALLAR STANDARTINA UYGUN HİZMET VEREN KAPISAP, ANIŞAP, METAL VE/VEYA PVC KAPI VE PENCERE/İÇİNE HİZMET VEREN
* DORTEK KAPI SAN. VE TİC. AŞ. YETKİLİ SERVİSİ (1079848)
(16.10.2011) (DORTEK) MARKALI

30.12.2014
SAHİN ÖZDEN
KASTAMONU/İZMİR/MEVKEİ W0040
Tarih: 30.12.2014



kiwa
Partner for progress

ATTESTATION OF CONFORMITY
Certificate Number: 1405-MTS-001

DORTEK KAPI SANAYİ VE TİCARET A.Ş.
Baraj Yolu İnözü Mvkü Kastamonu - Türkiye

Product: Monoblock door with frame and jamb
Model: 40 mm and 45 mm thickness

The above-mentioned product which has been tested according to the following specifications meets the basic requirements MEYER Product Certification procedures.
On the based samples taken from manufacturing site for testing is determined that the noise elimination efficiency is up to 42 dB.

Tested Report No: 1405-MTS-001
Primary problem/subject Report: 191-090801-001
No: 1405-MTS-001
Certificate Valid Until: 22.08.2015

This certificate has been issued by MEYER based on the samples taken from manufacturing site for testing and certification purposes. The manufacturer is hereby given the right to use the MEYER-TESTED Logo on the above-mentioned product.

23.08.2014
Güvenlik Uzmanı
R. ÖZDEN

TESTED
Noise Elimination
Efficiency Up To 46 dB
MEYER

Kiwa Meyer Belgelendirme Hizmetleri A.Ş.
T108B 9. Cadde No: 15 Tepeören - Tuzla - İstanbul - Türkiye
Tel: +90 216 502 21 71 Faks: +90 216 502 21 74
Web: www.kiwa.com.tr / www.belgenet.com.tr



SERTİFİKA
CERTIFICATE 证书 ZERTIFIKAT प्रमाण-पत्र CERTIFICATO

DORTEK KAPI SANAYİ VE TİCARET A.Ş.

MERKEZ: ALEMDAĞ CD. NO:48 D BLOK K:1 B ÇAMLIÇA - İSTANBUL - TÜRKİYE
FABRİKA: BARAJ YOLU İNÖZÜ MEVKİİ MERKEZ - KASTAMONU - TÜRKİYE

MONOBLOK DOLGU TEKNOLOJİSİ İLE ÜRETİLEN KAPI, PENCERE, MOBİLYA, MOBİLYA ÖNCESİ DEKORASYON MALZEMELERİ VE PETEK DOLGULU KAPILARIN TASARIMI, ÜRETİMİ, SATIŞI, PAZARLAMASI, UYGULAMASI VE SATIŞ SONRASI HİZMETLER kapsamında

OHSAS 18001:2007
İş Sağlığı ve Güvenliği Yönetim Sistemi Standardına uygun bir sistem kurmuştur.

Genel Müdür
MEYER

Sertifika periyodik ara denetimlerle beraber de sürdürülmesini kaydıyla geçerlidir. Detaylı bilgi için aşağıdaki numaralara başvurabilirsiniz.
MEYER Belgelendirme Hizmetleri A.Ş.
T108B 9. Cadde No: 15 Tepeören - Tuzla - İstanbul - Türkiye Tel: +90 216 502 21 71 Faks: +90 216 502 21 74
www.kiwa.com.tr / www.belgenet.com.tr

Sertifika Son Güncellenme Tarihi: 23 Ağustos 2014 - 09

CERTIFICATES



KALİTE

En temel değerlerimizden biri de müşterilerimize taahhüt ediyor olduğumuz yüksek kalite standartlarıdır. Dortek ürünlerinde kullanılan tüm bileşenler, yılların ortaya koyduğu deneyimle, titizlikle seçilir. Kullanılan ahşap lif levha, astar, boya, kaplamalar, aksesuarlar ve diğer bileşenler, Dortek kalite çizgisine paralel olacak şekilde Avrupa Birliği normlarına uygun, sertifikasyonları tamamlanmış tedarikçilerden temin edilir ve DIN normlarında olmasına özellikle dikkat edilir. Ürün geliştirme çalışmalarında, üretilen her yeni ürün, yaşlandırma deneylerine tabi tutulur. Hizmete sunulmadan önce kalite kontrol süreçleri özenle takip edilir. Keşif, ölçü, demontaj ve montaj hizmetlerini satışın ayrılmaz bütünlüğü içerisinde tamamlayan Dortek'in en önemli ilkesi, müşteri memnuniyetini üst düzeyde sağlamaktır. Kaliteye olan tutkumuzla, sizlere bir üründen çok daha fazlasını sunuyoruz. Korumak, konfor sağlamak, bir tarzı ifade etmek ve değer yaratmak için tasarlanmış ürün ve hizmetler. Bizden bekleyebileceğiniz bunlardır.

QUALITY

One of our most fundamental values is the high quality standards that we are committed to our customers. All components used in Dortek products are meticulously selected with years of experience. The wood fiber board, lining, paint, coatings, accessories and other components used are supplied from certified suppliers compliant with European Union norms in line with the Dortek quality line and pay particular attention to being in DIN norms. In product development studies, every new product produced is subjected to aging tests. Quality control processes are followed carefully before being submitted to the service. The most important principle of Dortek, which completes discovery, measurement, disassembly and assembly services within the integral part of sale, is to provide customer satisfaction at a high level. With our passion for quality, we offer you far more than a product. Products designed to protect, provide comfort, express style and create value services. These are the things you can expect from us.

13-15



MODEL ÖN İZLEMELERİ

Serilerde uygulanabilen tüm modellere kısa bir genel bakış. 18 farklı modelden oluşan Aden kapıları, tercih edeceğiniz malzeme tipine göre polimerik veya lake olmak üzere iki farklı yüzey bitim malzemesinden biri ile tamamlanıyor.

MODEL PREVIEWS

An overview of all applicable models in the series. Aden doors, which consist of 18 different models to choose are completion with two different finishing surface materials as polymeric or lacquered.



VERITAS MODEL SERİSİ

Düz ve camlı olmak üzere iki farklı modelden oluşan bu seride fuga veya profil detayı olmaksızın sade ve şık bir görünüm elde edilir. Veritas modelleri ile her zevke hitap edebilir veya farklı tasarımlara uyum sağlayabilirsiniz.

VERITAS MODEL SERIES

In this series, which includes two different models as flat and glazed doors, you can get a simple and stylish look without any joint or profile details. With Veritas models, you can pleasing to all tastes or you can adapt to different designs.

POLİMERİK / POLYMERIC

Aden polimerik kaplama ürünleri, farklı renk ve desenlerden oluşan toplamda altı ayrı seçenekte sunulur. Lamine ahşap ve renk kaplama uygulamaları ile yüksek mukavemetli yoğunlukta üretilir. Bu özelliği sayesinde darbe ve çizilmelere karşı güçlü dayanıma sahiptir.

Aden polymeric veneer products presents six options with different colors and patterns. Polymeric models produced in high strength density with laminated wood veneer and color coating applications. Products has strong resistance against impacts and scratches because of this feature.

LAKE / LACQUERED

Aden lake boyalı ürünleri, iki farklı renk seçeneği ile sunulur. Mat ve ipeksi yüzeyi ile zarif bir görünüme sahiptir. Ahşap üzerine uygulanan astar katları, homojen ve boyanın tutunmasına uygun, pürüzsüz bir yüzey elde edilmesini sağlar ve sizlere lakenin ihtişamını sunar.

Aden lacquer products presents two different colors options. With matt and flossy surface products have elegant appearance. Lining coats applied on wood provide a smooth surface that is homogeneous and suitable for the adhesion of lacquer and offers you the magnificence of the lacquer.



PONTE MODEL SERİSİ

Farklı desen ve şekillerde yaratıcı modern tasarımlara yer verilen bu seride, 10 farklı model sunulmakta. Minimal detaylar ile oluşturulan seçeneklerden konsept ve tarzınıza uygun bir tercih yapabilirsiniz.

PONTE MODEL SERIE

In this series, which includes creative modern designs in different patterns and shapes with presented 10 different models. You can make a choice that suits your concept and style from created options with minimal details.

POLİMERİK / POLYMERIC

Aden polimerik kaplama ürünleri, farklı renk ve desenlerden oluşan toplamda altı ayrı seçenekte sunulur. Lamine ahşap ve renk kaplama uygulamaları ile yüksek mukavemetli yoğunlukta üretilir. Bu özelliği sayesinde darbe ve çizilmelere karşı güçlü dayanıma sahiptir.

Aden polymeric veneer products presents six options with different colors and patterns. Polimeric models produced in high strength density with laminated wood veneer and color coating applications. Products has strong resistance against impacts and scratches because of this feature.

LAKE / LACQUERED

Aden lake boyalı ürünleri, iki farklı renk seçeneği ile sunulur. Mat ve ipeksi yüzeyi ile zarif bir görünüme sahiptir. Ahşap üzerine uygulanan astar katları, homojen ve boyanın tutunmasına uygun, pürüzsüz bir yüzey elde edilmesini sağlar ve sizlere lakenin ihtişamını sunar.

Aden lacquer products presents two different colors options. With matt and flossy surface products have elegant appearance. Lining coats applied on wood provide a smooth surface that is homogeneous and suitable for the adhesion of lacquer and offers you the magnificence of the lacquer.



LUX MODEL SERİSİ

Zengin profil detayları ile birlikte zarif hatlara sahip bu modellerde kullanılan klasik-modern çizgiler, göz alıcı bir görünüm elde edilmesini sağlar. Serilerin en detaylı profil açıklıklarına sahip modelleri bu grupta yer almaktadır.

LUX MODEL SERIES

In these models have stylish lines together with luxury profile details, provide an eye-catching look with classic-modern lines. This group includes the models with the most detailed profile gaps of the series.

POLİMERİK / POLYMERIC

Aden polimerik kaplama ürünleri, farklı renk ve desenlerden oluşan toplamda altı ayrı seçenekte sunulur. Lamine ahşap ve renk kaplama uygulamaları ile yüksek mukavemetli yoğunlukta üretilir. Bu özelliği sayesinde darbe ve çizilmelere karşı güçlü dayanıma sahiptir.

Aden polymeric veneer products presents six options with different colors and patterns. Polymeric models produced in high strength density with laminated wood veneer and color coating applications. Products has strong resistance against impacts and scratches because of this feature.

LAKE / LACQUERED

Aden lake boyalı ürünleri, iki farklı renk seçeneği ile sunulur. Mat ve ipeksi yüzeyi ile zarif bir görünüme sahiptir. Ahşap üzerine uygulanan astar katları, homojen ve boyanın tutunmasına uygun, pürüzsüz bir yüzey elde edilmesini sağlar ve sizlere lakenin ihtişamını sunar.

Aden lacquer products presents two different colors options. With matt and flossy surface products have elegant appearance. Lining coats applied on wood provide a smooth surface that is homogeneous and suitable for the adhesion of lacquer and offers you the magnificence of the lacquer.

36-39



ÖLÇÜ VE DETAY

Kapınızın ölçü seçeneklerine, kapı yön referans görsellerine ve standart olarak sunulan kapı donanım görsellerine buradan ulaşabilirsiniz.

Ayrıca sade, ulaşılabilir ve ergonomik olan Aden kol seti detaylarını inceleyebilirsiniz.

MEASUREMENT AND DETAIL

You can find the size options, opening direction, reference images and standard hardwares of doors details in here.

You can also view the details of the simple, accessible and ergonomic Aden handle set.

40-41



RENK PALETİ

Aden'e özel, polimerik yüzey kaplamalarına ve ipeksi mat lake boya uygulama renklerini inceleyebilirsiniz.

Toplamda 6 seçenekten oluşan bir skala sunuluyor.

COLOR PALETTE

You can view the polymeric surface veneer and silky matt lacquer paint application colors specific to Aden.

6 different colour options presents from scale.

MODEL ÖN İZLEMELERİ





005



C108-G

V E R I T A S
M O D E L
S E R I E
B A S I C
M I N I M A L

L U X
M O D E L
S E R I E
M A J O R
E L E G A N C E



138



707



098



C098-G



018



C018-G

7F2



C108-G5



5F1



5F2



PONTI
SERRI

420



410



MODELS IN
WHITE

CONTAINS
LACQUER
POLYMERIC
FINISHES

MODERN
DESIGNS
WITH GAPS

703



704



710



711



C108-G



VERITAS

AAD

005



EN

N

VERITAS

VERITAS

005

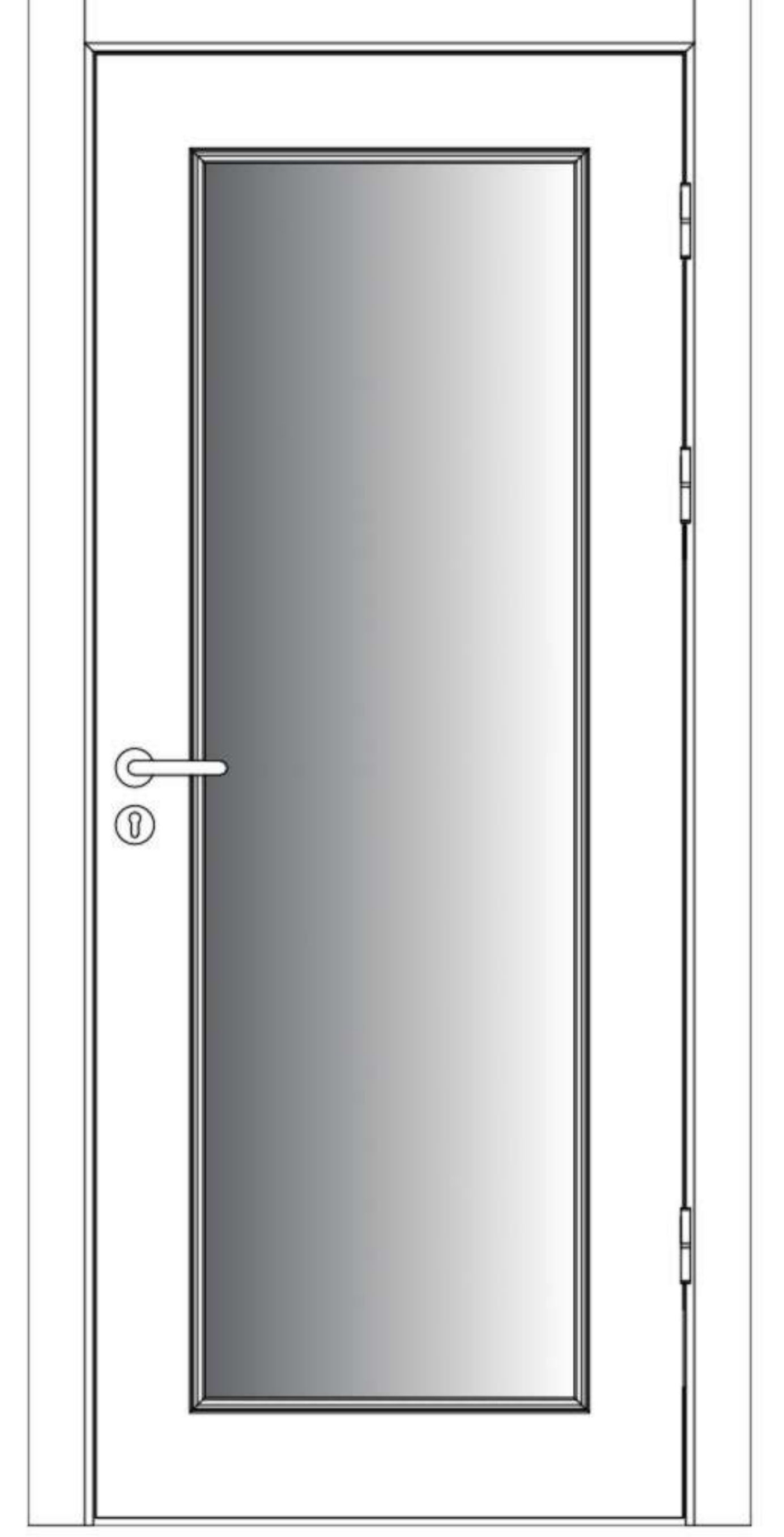
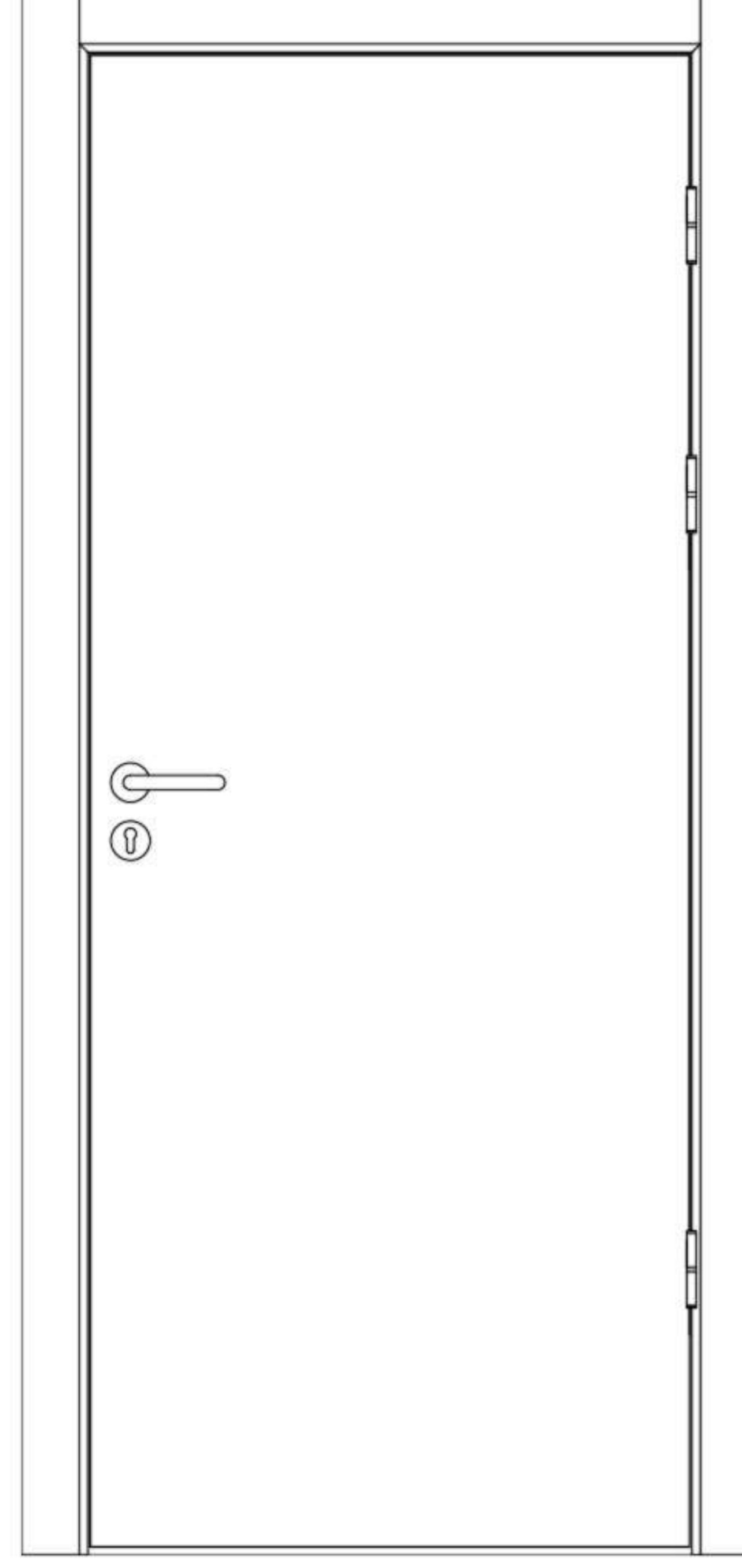

0 0 5

C108-G



AÇIK MEŞE / LIGHT OAK
POLİMERİK / POLYMERIC



CINAR / PLANE
POLİMERİK / POLYMERIC



TİK / TEAK
POLİMERİK / POLYMERIC

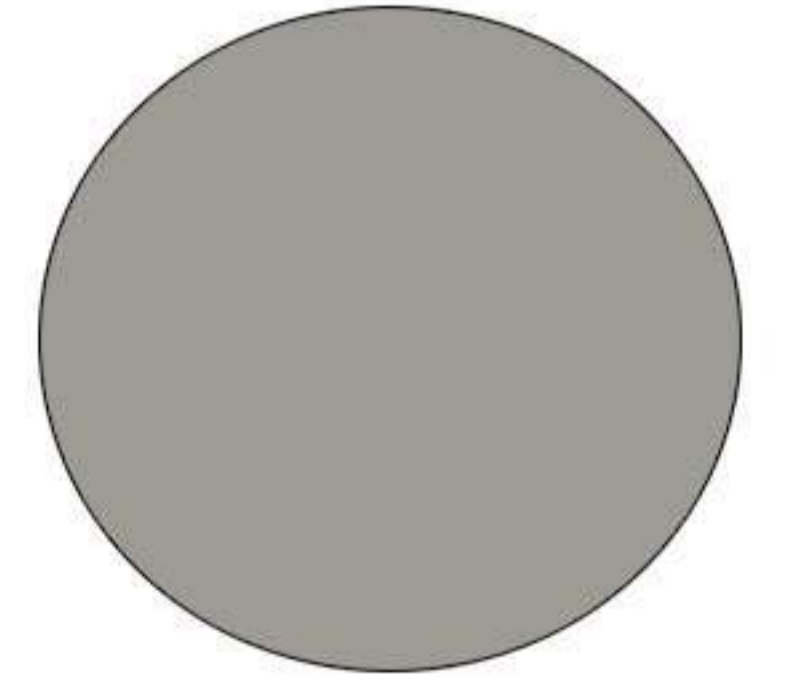

TAŞ GRİ / STONE GREY
POLİMERİK / POLYMERIC

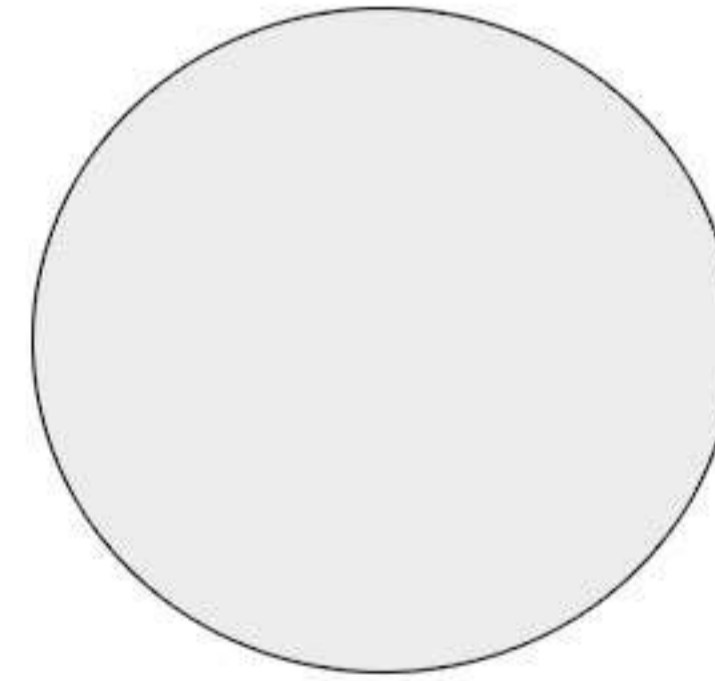

SOFT BEYAZ / SOFT WHITE
POLİMERİK / POLYMERIC

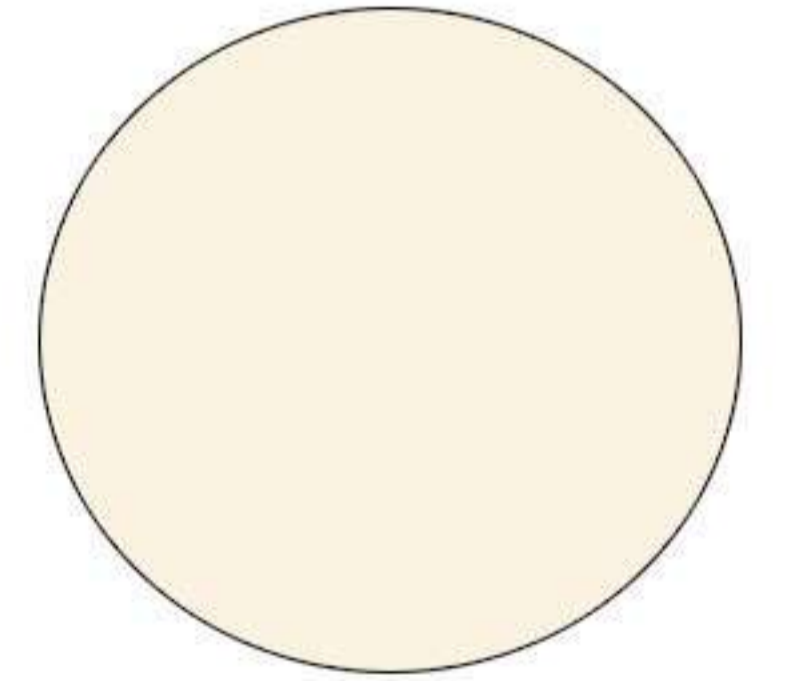

KREM / CREAM
POLİMERİK / POLYMERIC

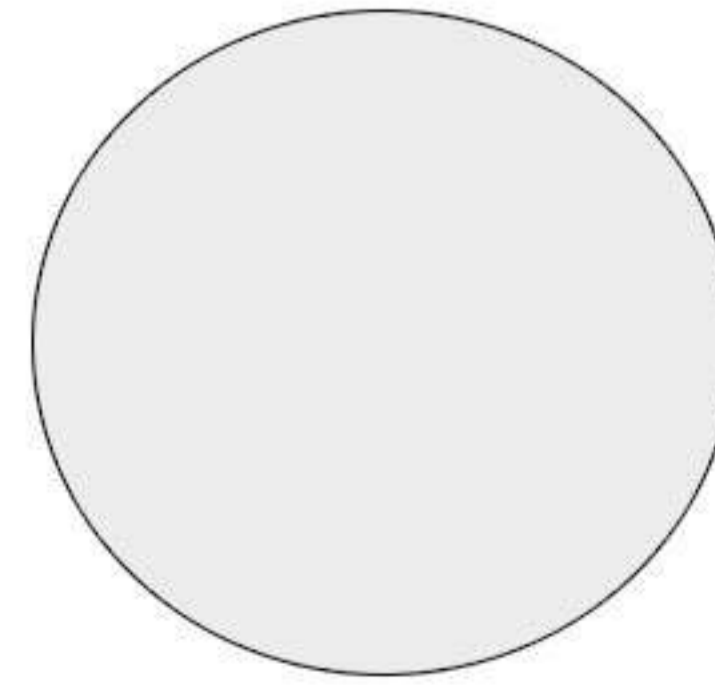

BEYAZ / WHITE
LAKE / LACQUER

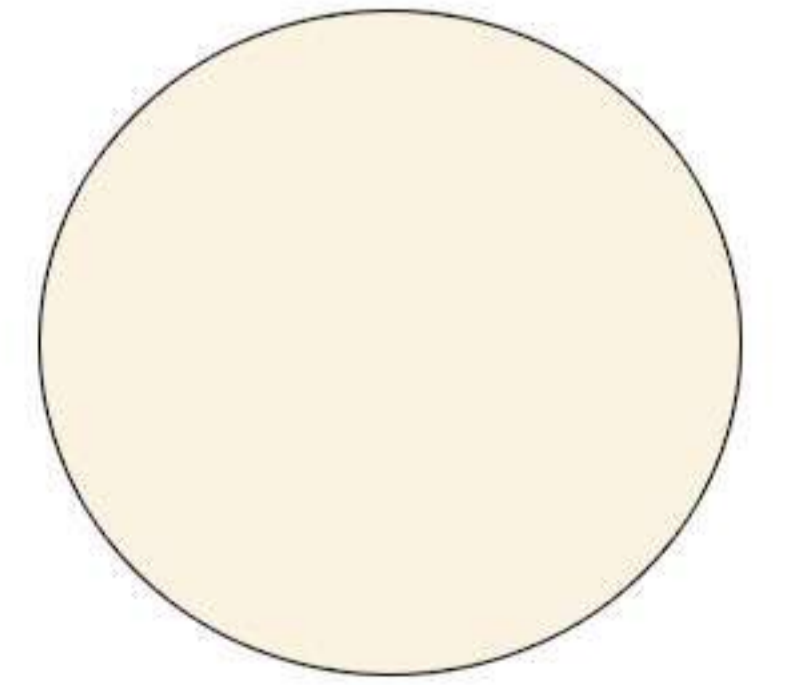

FİLDİŞİ / IVORY
LAKE / LACQUER

Düz ve camlı olmak üzere iki farklı modelden oluşan bu seride fuga veya profil detayı olmaksızın sade ve şık bir görünüm elde edilir. Veritas modelleri ile her zevke hitap edebilir veya farklı tasarımlara uyum sağlayabilirsiniz.

In this series, which includes two different models as flat and glazed doors, You can get a simple and stylish look without any joint or profile details. With Veritas models, you can pleasing to all tastes or you can adapt to different designs.

FRAME

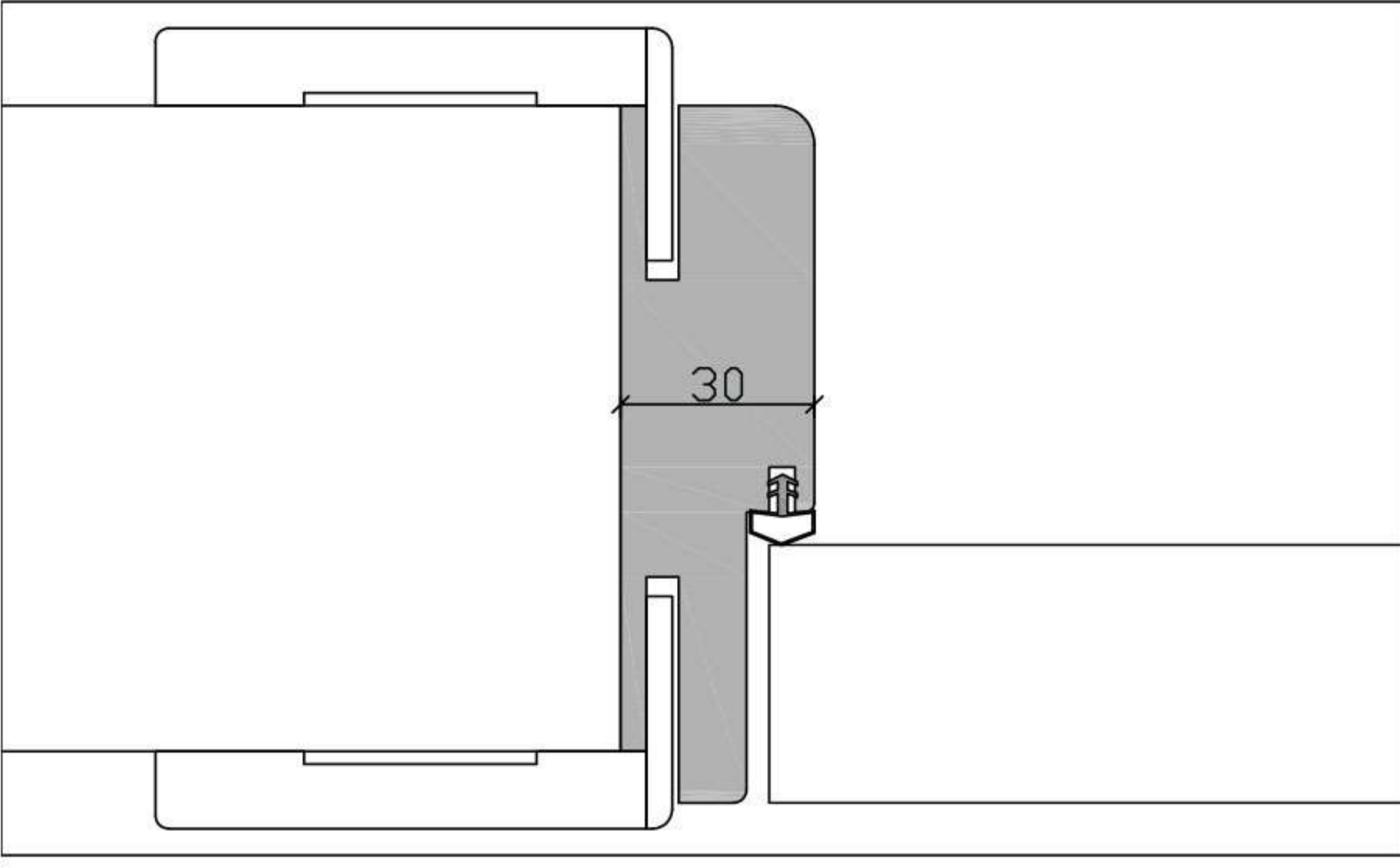

LEAF

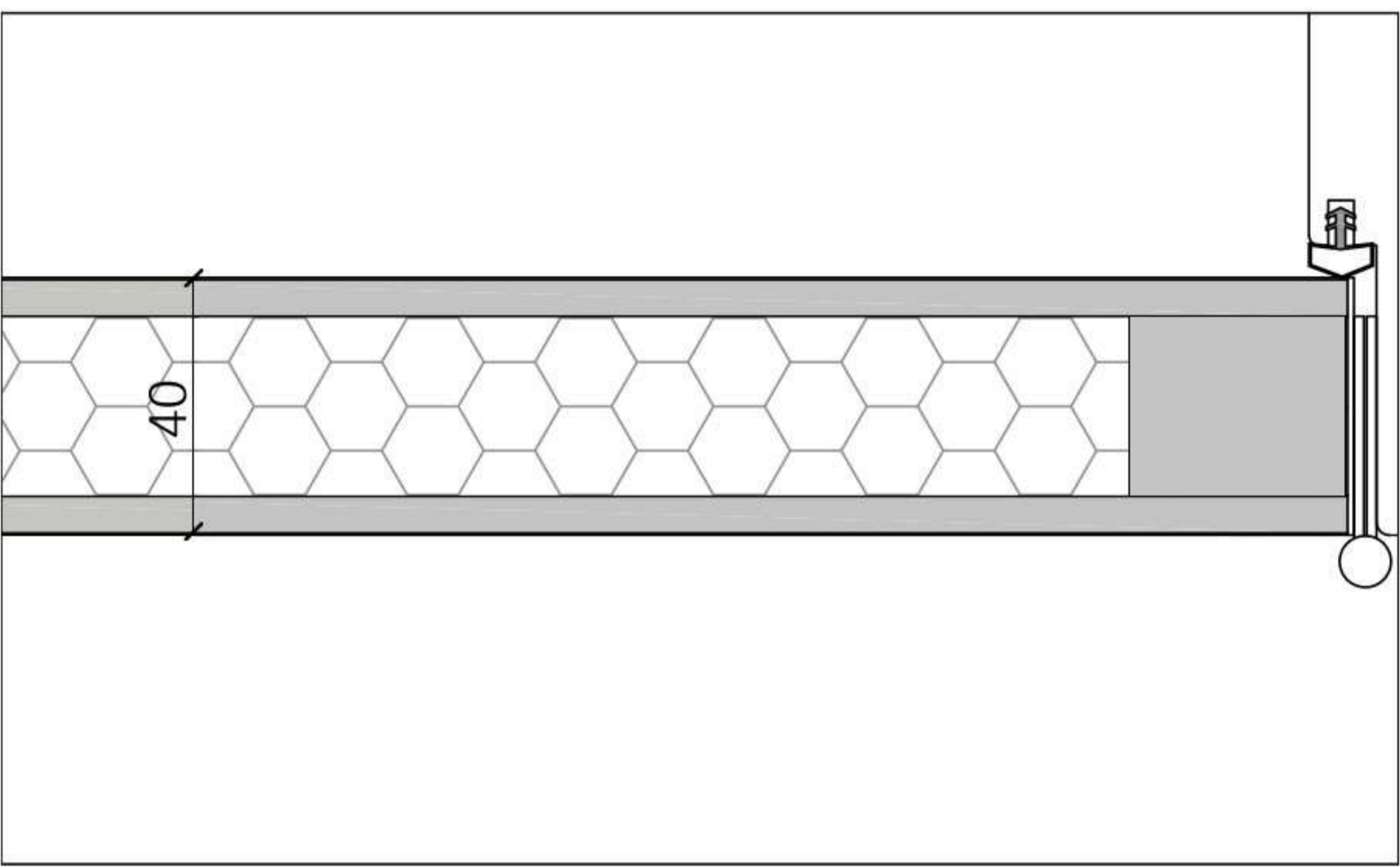

ARCHITRAVE

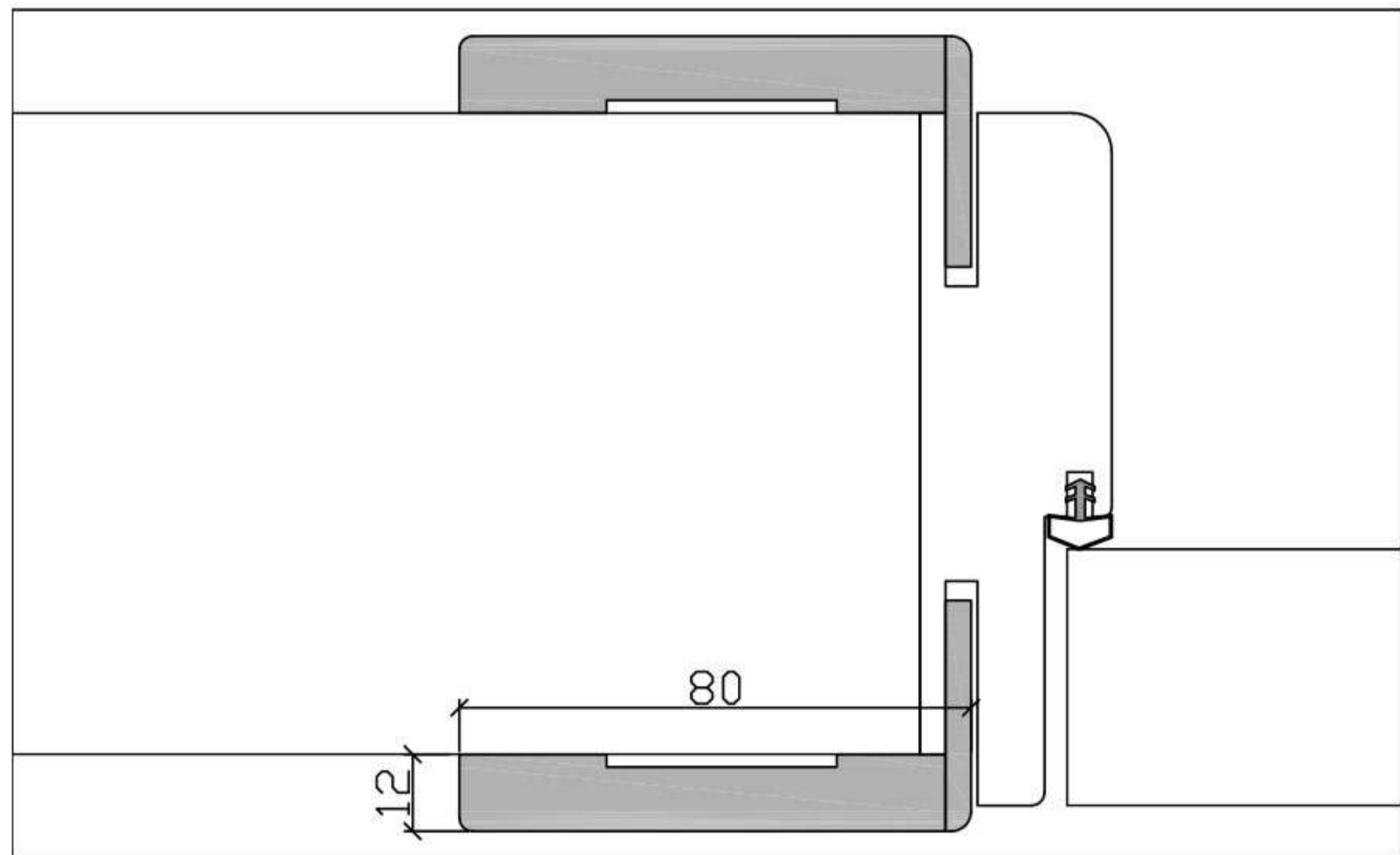

HARDWARE

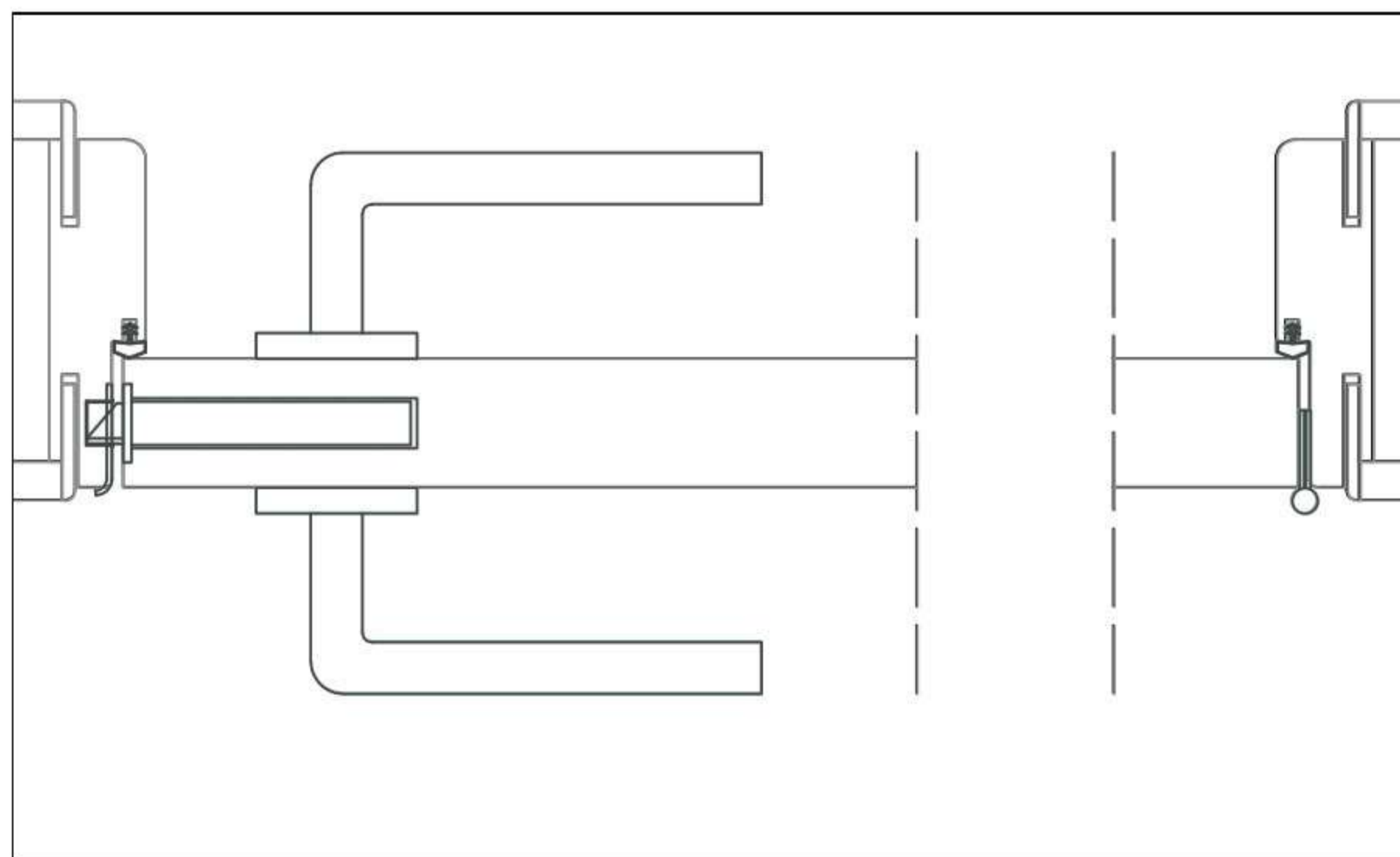

KASA

Aden serisi kapılarında, 30 mm MDF kasa standart olarak sunulur. Yüzeyler seçilen malzeme ve renkte tanımlanır. Kasa montaj öncesinde yerinde birleştirilir ve duvarla arasında kalan boşlukta 15 mm poliüretan dolgu malzemesi kullanılır. Duvar derinliğine göre farklı ölçü seçenekleri sunulmaktadır.

In Aden series doors, 30 mm MDF frame provided as standard. Surface defined with the selected material. Frame is assembled in the place before installation and the space between wall and frame fills with 15 mm polyurethane foam. Different size options are offered according to the depth of the wall.

KANAT

Tüm kapı modellerinde standart olarak 12mm kalınlığında 80 mm genişliğinde düz model mdf pervaz kullanılır. Pervaz yüzeyi kapı yüzeyi ile aynı malzeme/renk seçeneklerinden tercih edilir. Kapı üst başlık pervazı yan pervazlar arasında yerleştirilerek 90 derece köşe birleşim detayı sağlanmış olur.

Leafes are produced by fir wood door carcass with MDF surfaces on it and coated/painted with selected material. Total leaf thickness is 40 mm and side surfaces covered with edge band. Filler honeycomb is applied to the inner space.

PERVAZ

Tüm modellerde standart olarak 12 mm kalınlığında, 80 mm genişliğinde MDF pervaz çerçeveleri kullanılır. Yüzeyler seçilen malzemede tanımlanır. Pervazlar, kasa içerisine geçirilerek sabitlenir. Köşe pervaz 90° detayında birleştirilir. Yatay pervaz, dikey pervazların arasında konumlanır.

Architraves are standard in all models with 12 mm thickness and 80 mm MDF. Surfaces defined with the selected material. Arches slides inside of the frame and fixed. Upper corners joins together on 90° detail. Horizontal architrave is placed between vertical architraves.

AKSESUAR

Kapı temel elemanlarına ek olarak üçlü menteşe seti, kilit seti, kilit karşılığı ve model ile uyumlu fitil kapı seti ile birlikte gelir. Kol seti yuvası ise seçilen ilgili aralıktaki modele göre açılır ve ayrıca uygulanır. Opsiyonel olarak standart Aden kol setini de ürününüze ekleyebilirsiniz.

In addition to the basic elements of door, triple hinge set, lock counterpart and seal (compatible with door), comes with the product. Handle set slots opens according to model and applied separately. Optionally, you can add standard Aden handle set to your product.

410



PONTE

AD

711



PONTE

P O N T E

7F2

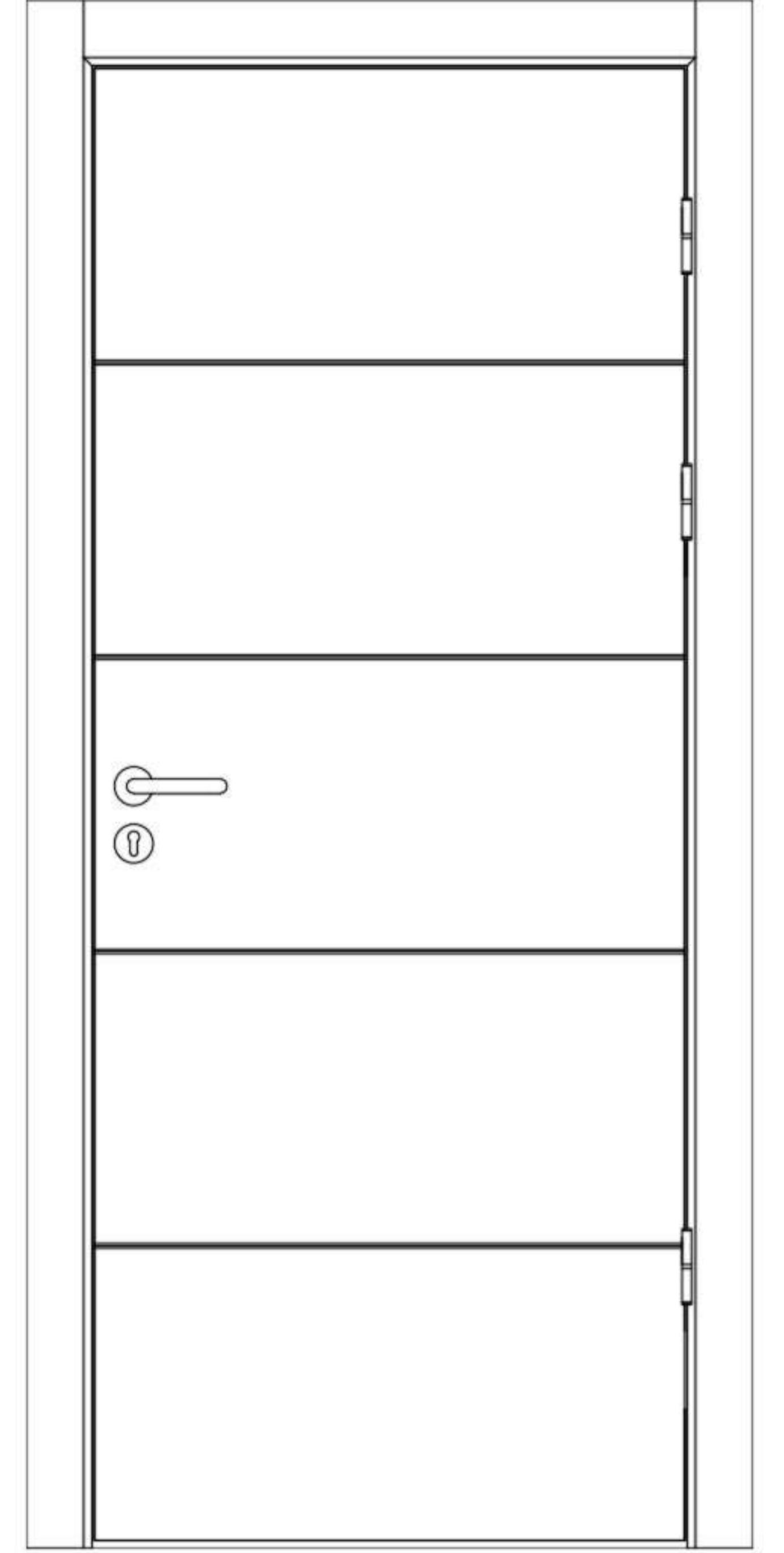
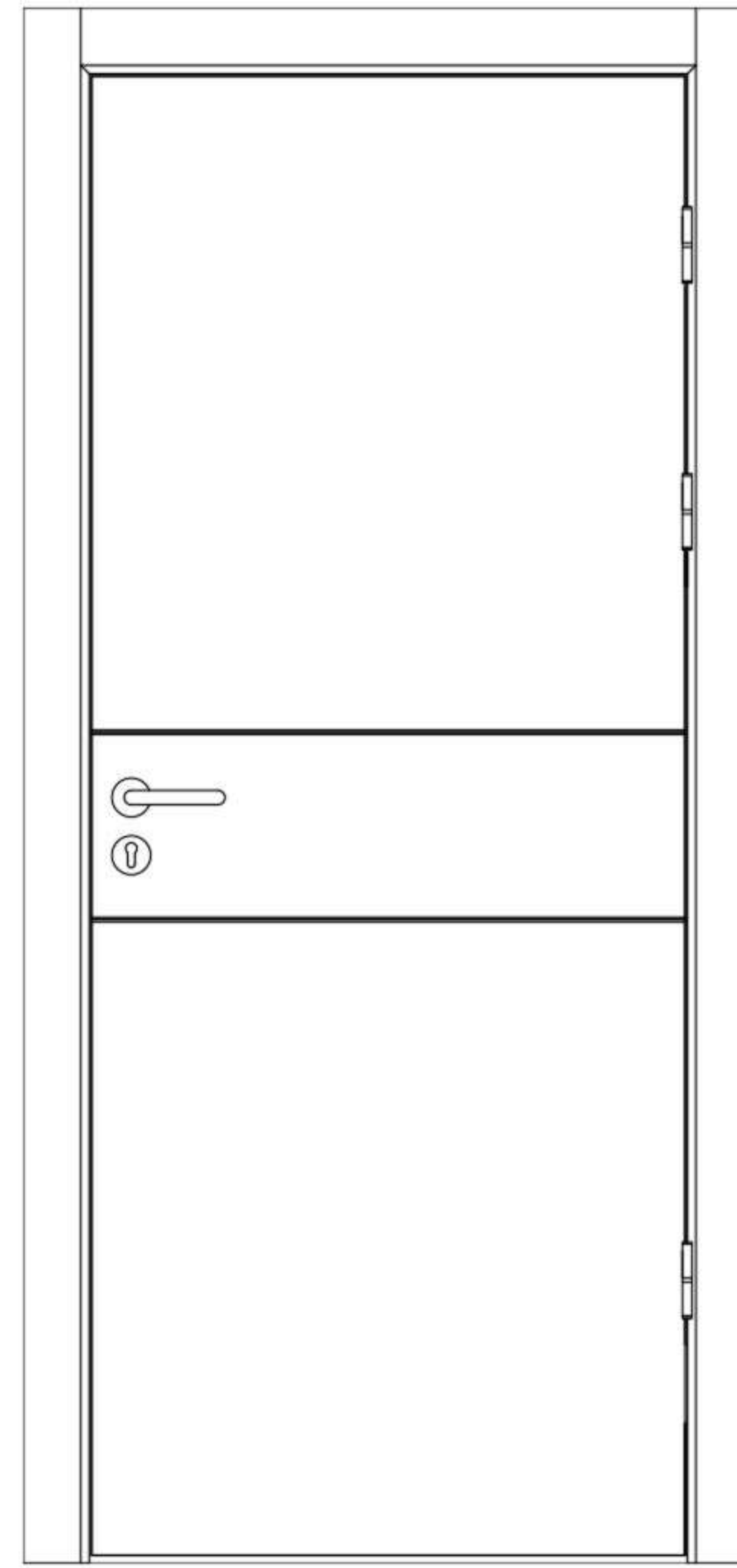

5 F 1

5 F 2



AÇIK MEŞE / LIGHT OAK
POLİMERİK / POLYMERIC



CINAR / PLANE
POLİMERİK / POLYMERIC



TİK / TEAK
POLİMERİK / POLYMERIC

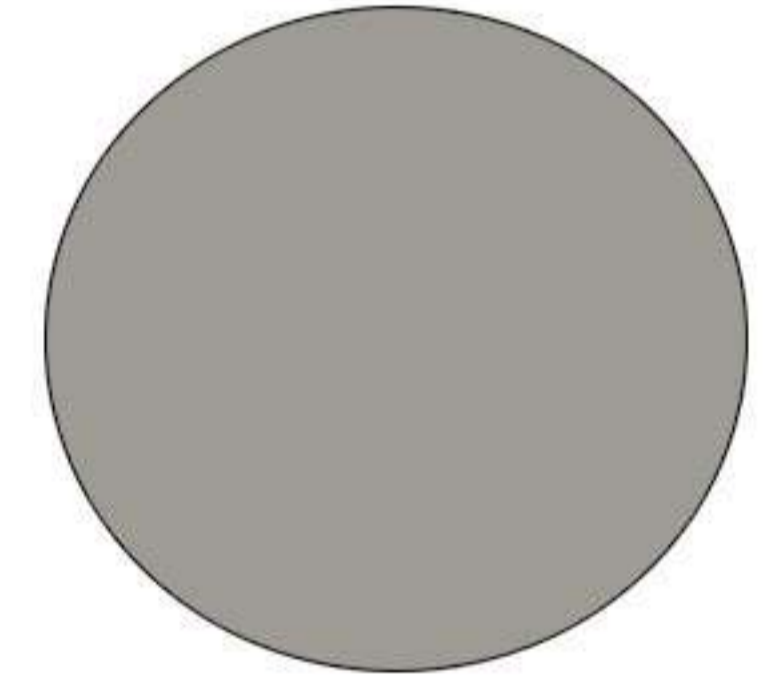

TAŞ GRİ / STONE GREY
POLİMERİK / POLYMERIC

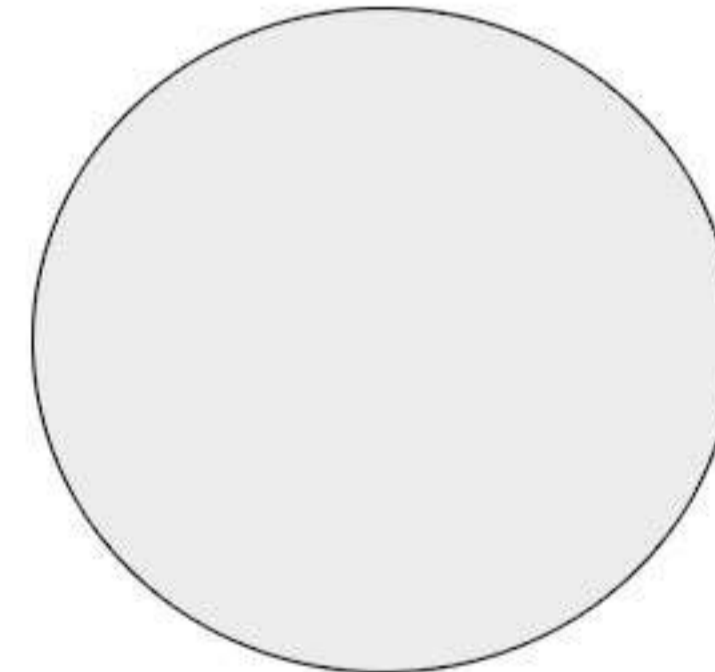

SOFT BEYAZ / SOFT WHITE
POLİMERİK / POLYMERIC

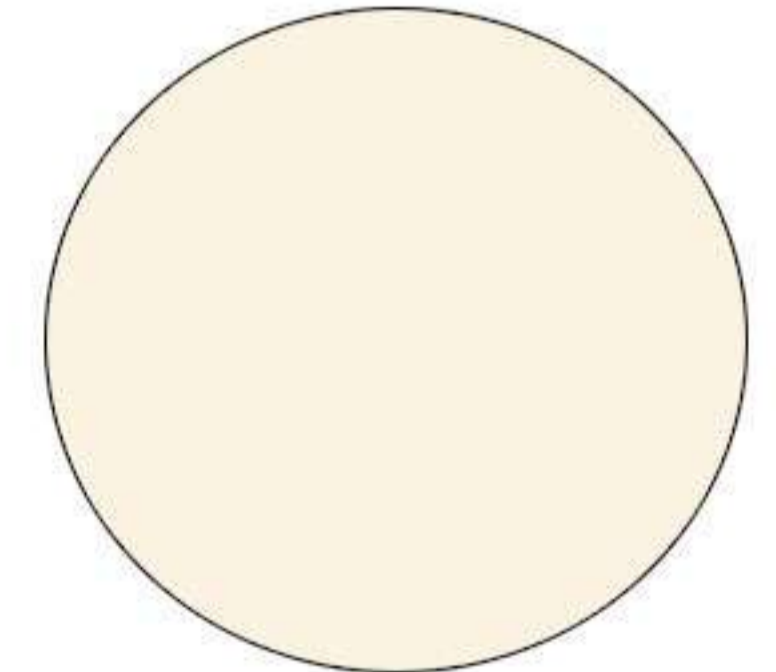

KREM / CREAM
POLİMERİK / POLYMERIC

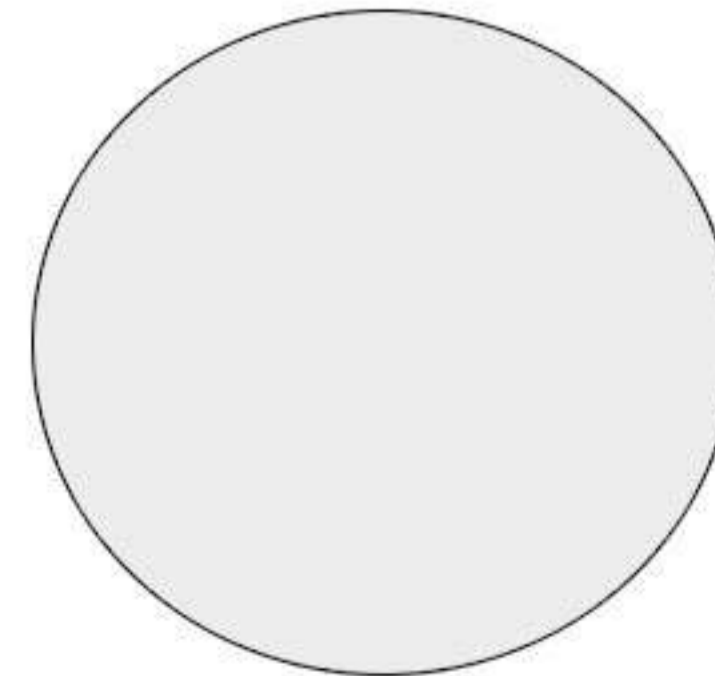

BEYAZ / WHITE
LAKE / LACQUER

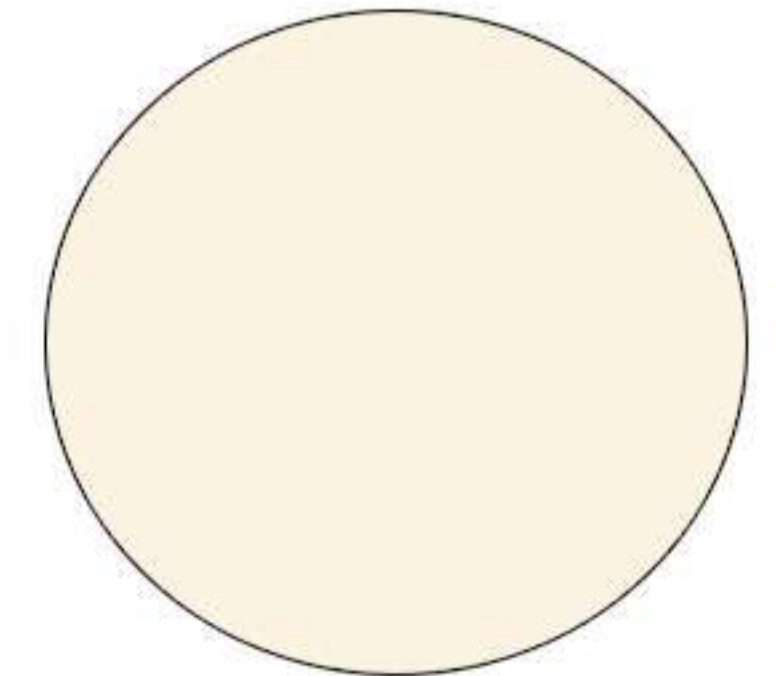

FİLDİŞİ / IVORY
LAKE / LACQUER

Farklı desen ve şekillerde yaratıcı modern tasarımlara yer verilen bu seride, 10 farklı model sunulmakta. Minimal detaylar ile oluşturulan seçeneklerden konsept ve tarzınıza uygun bir tercih yapabilirsiniz.

In this series, which includes creative modern designs in different patterns and shapes with presented 10 different models. You can make a choice that suits your concept and style from created options with minimal details.

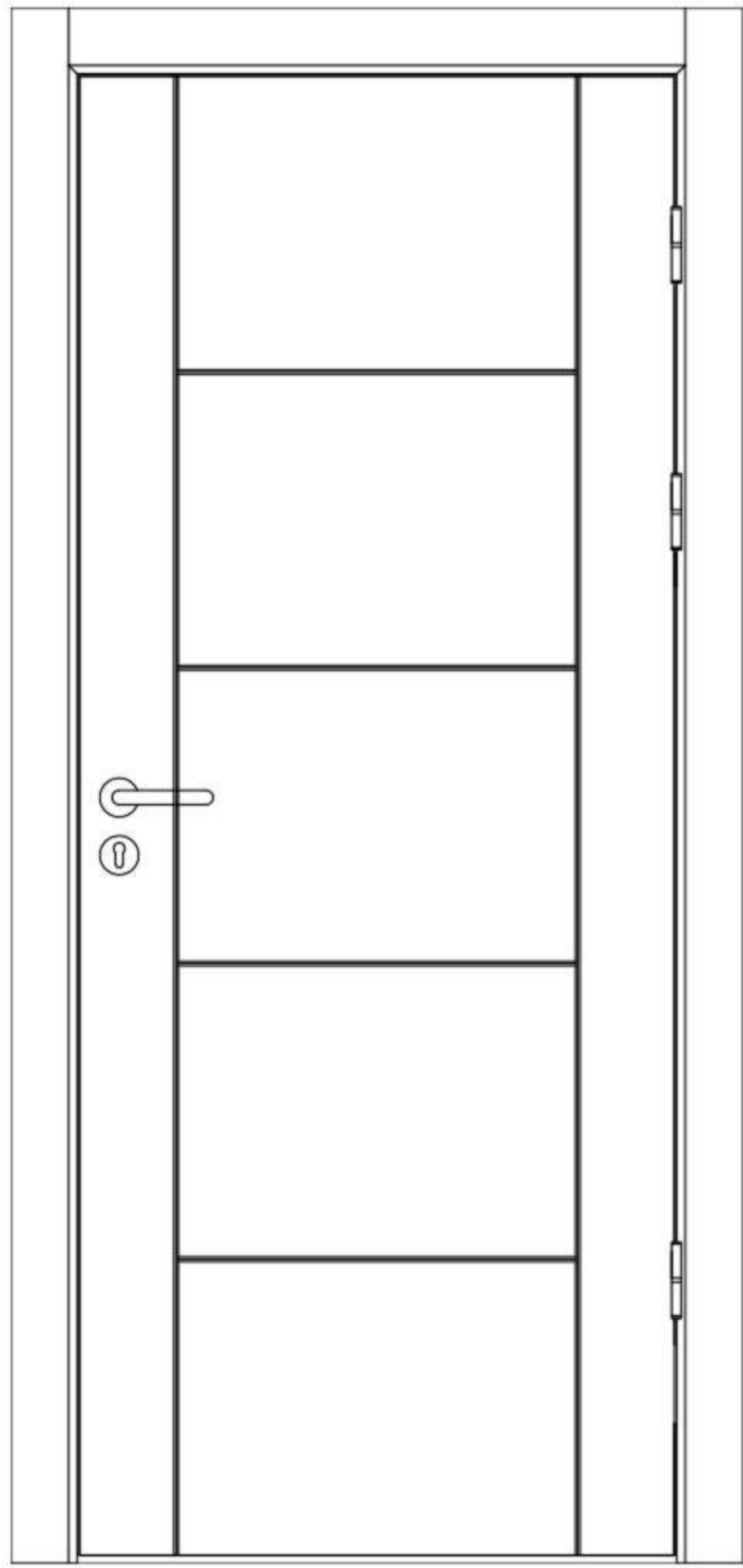

7 F 2

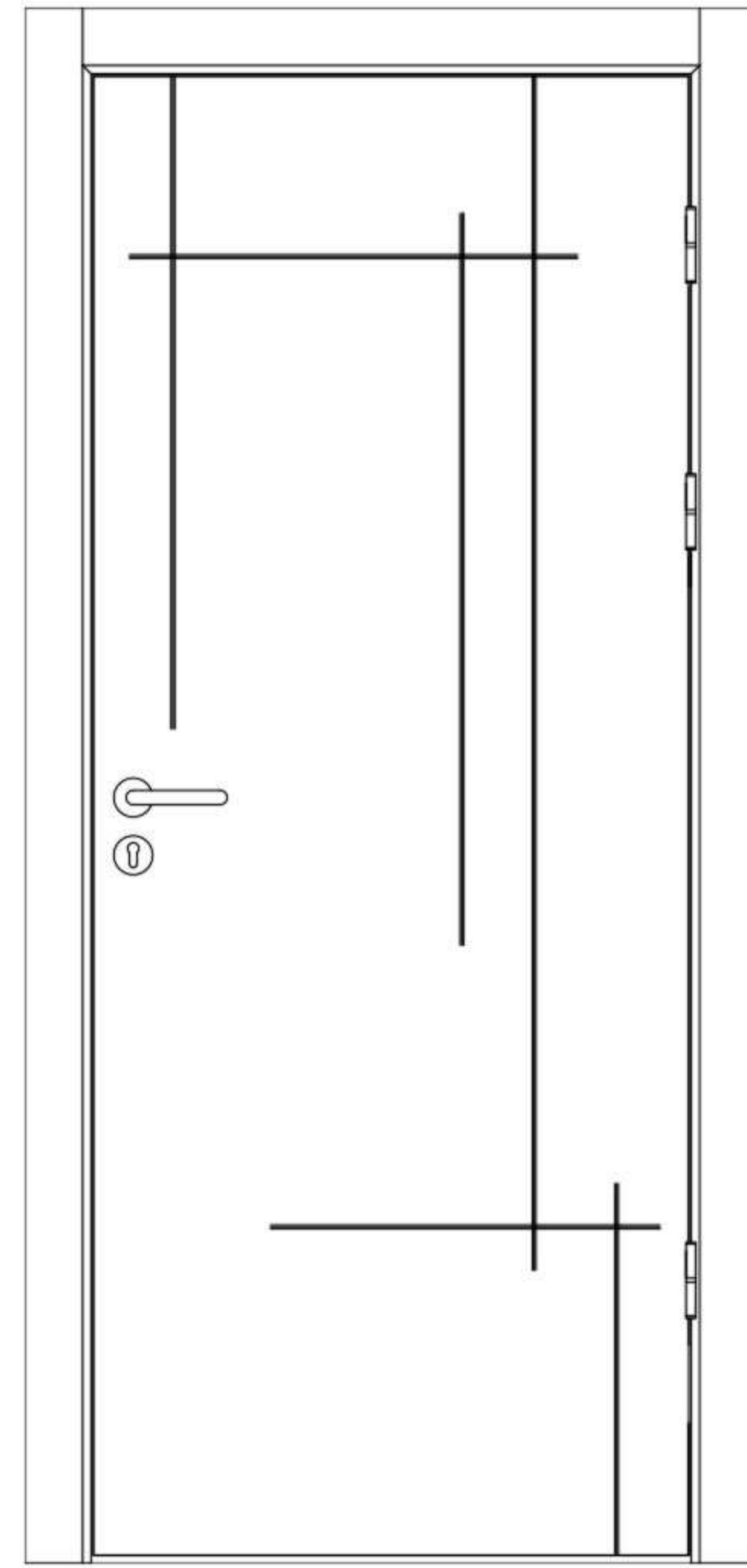

7 0 3

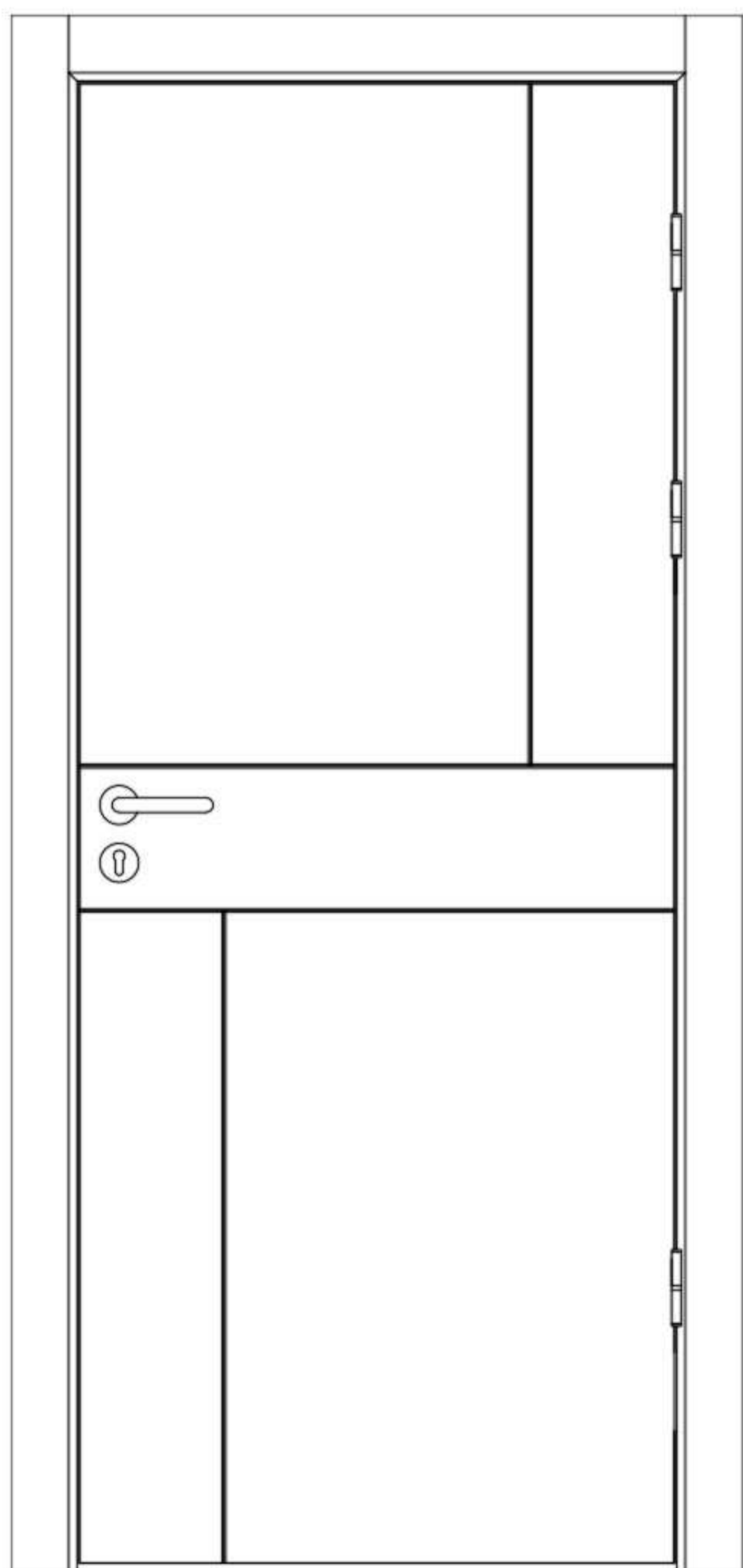

7 0 4

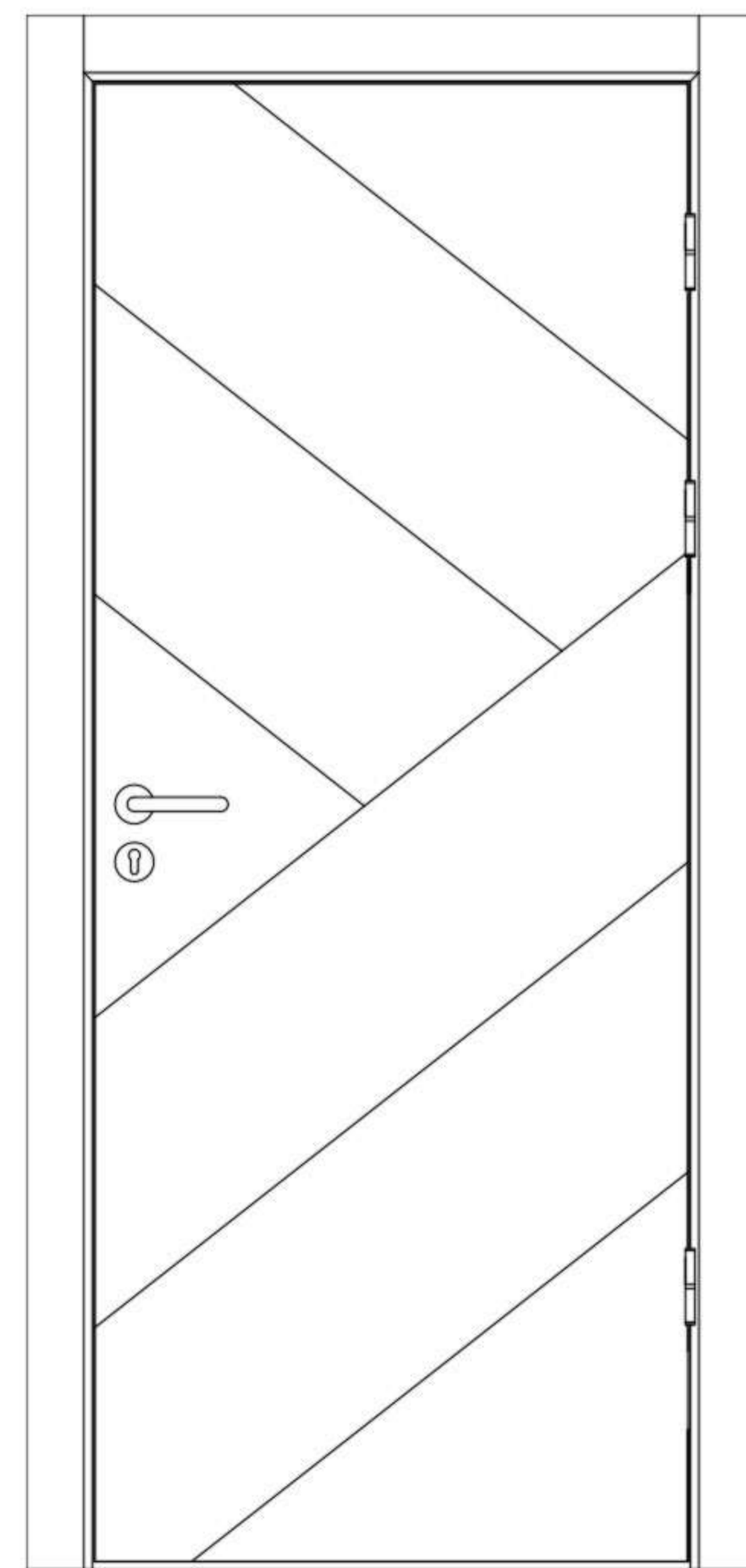

7 1 0

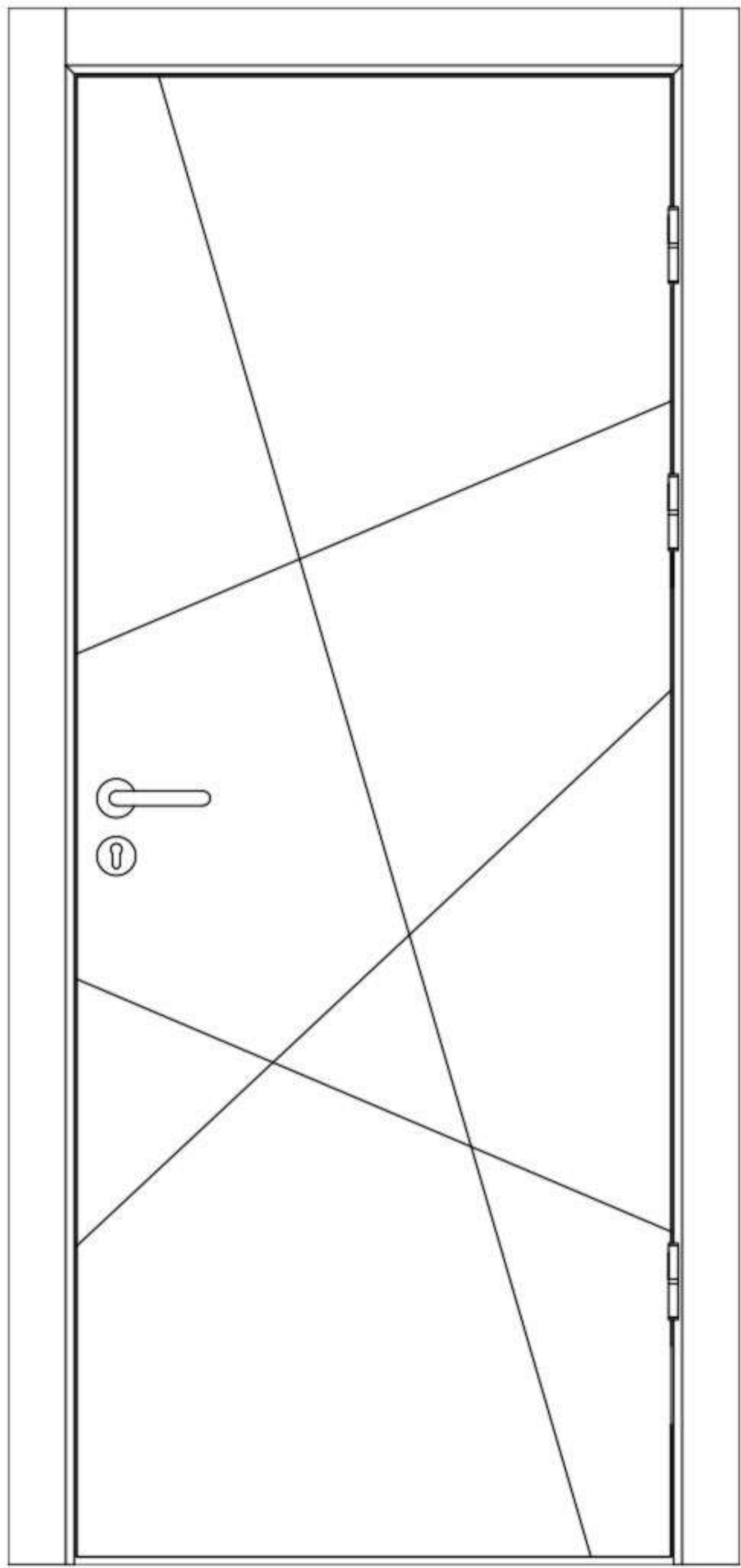

7 1 1

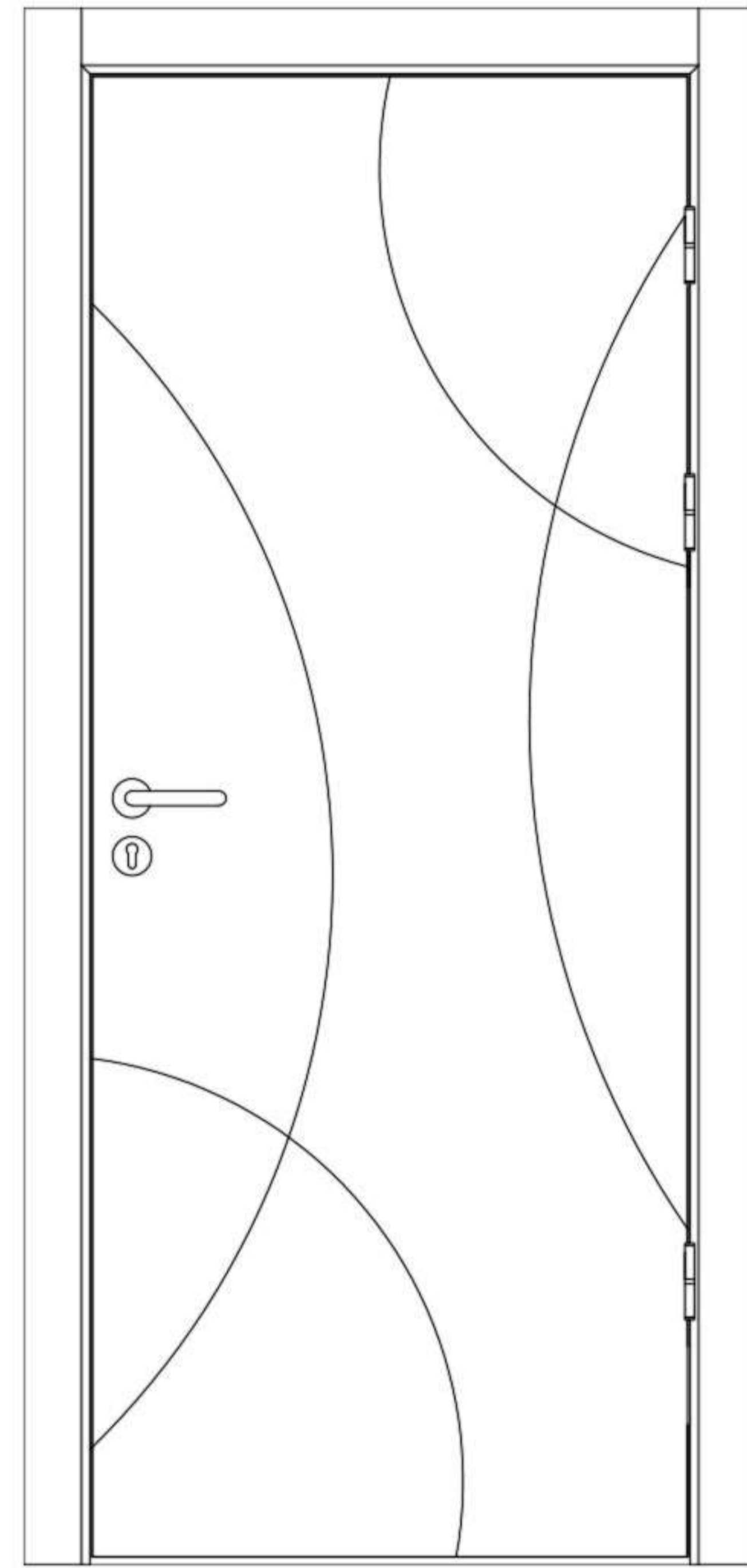

4 1 0

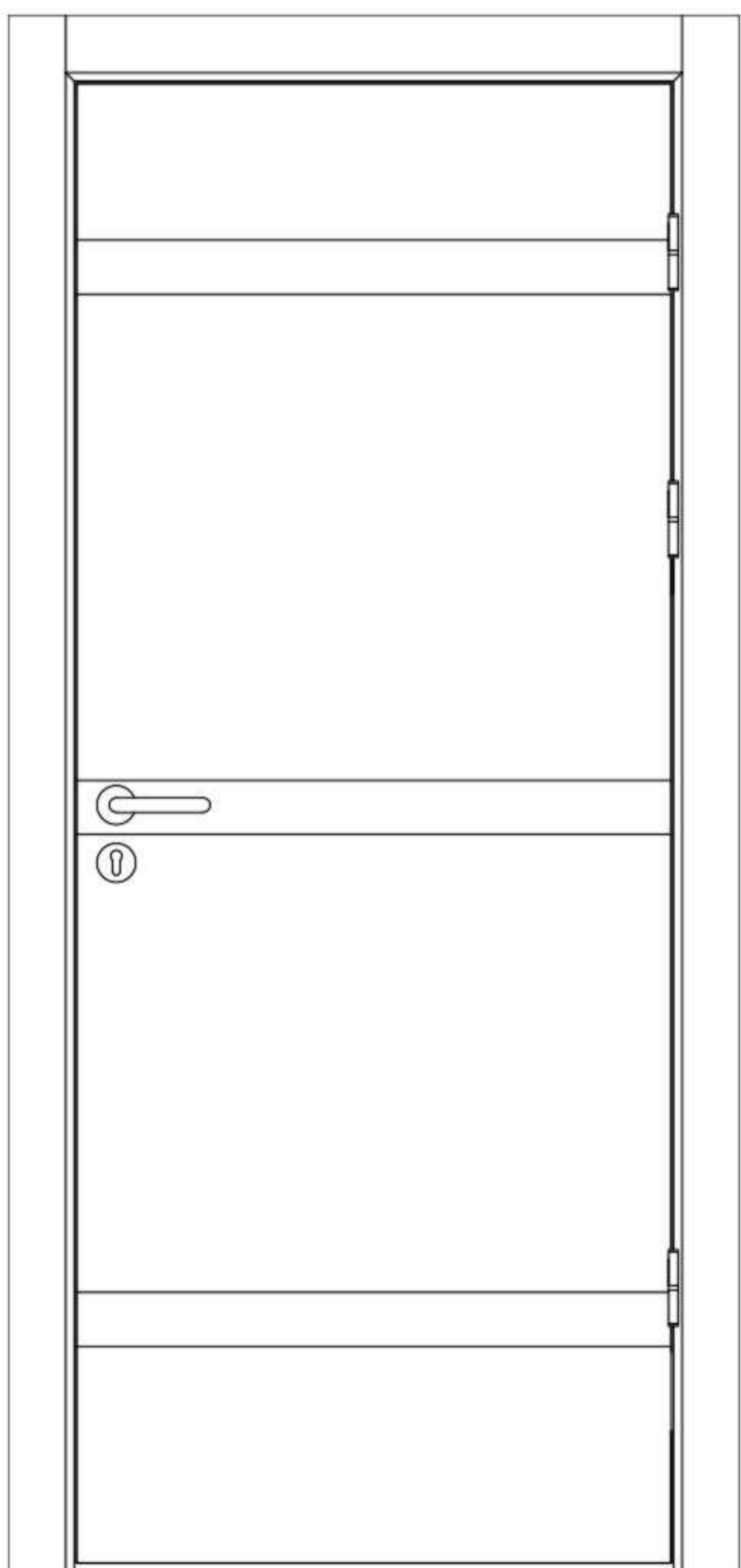

4 2 0

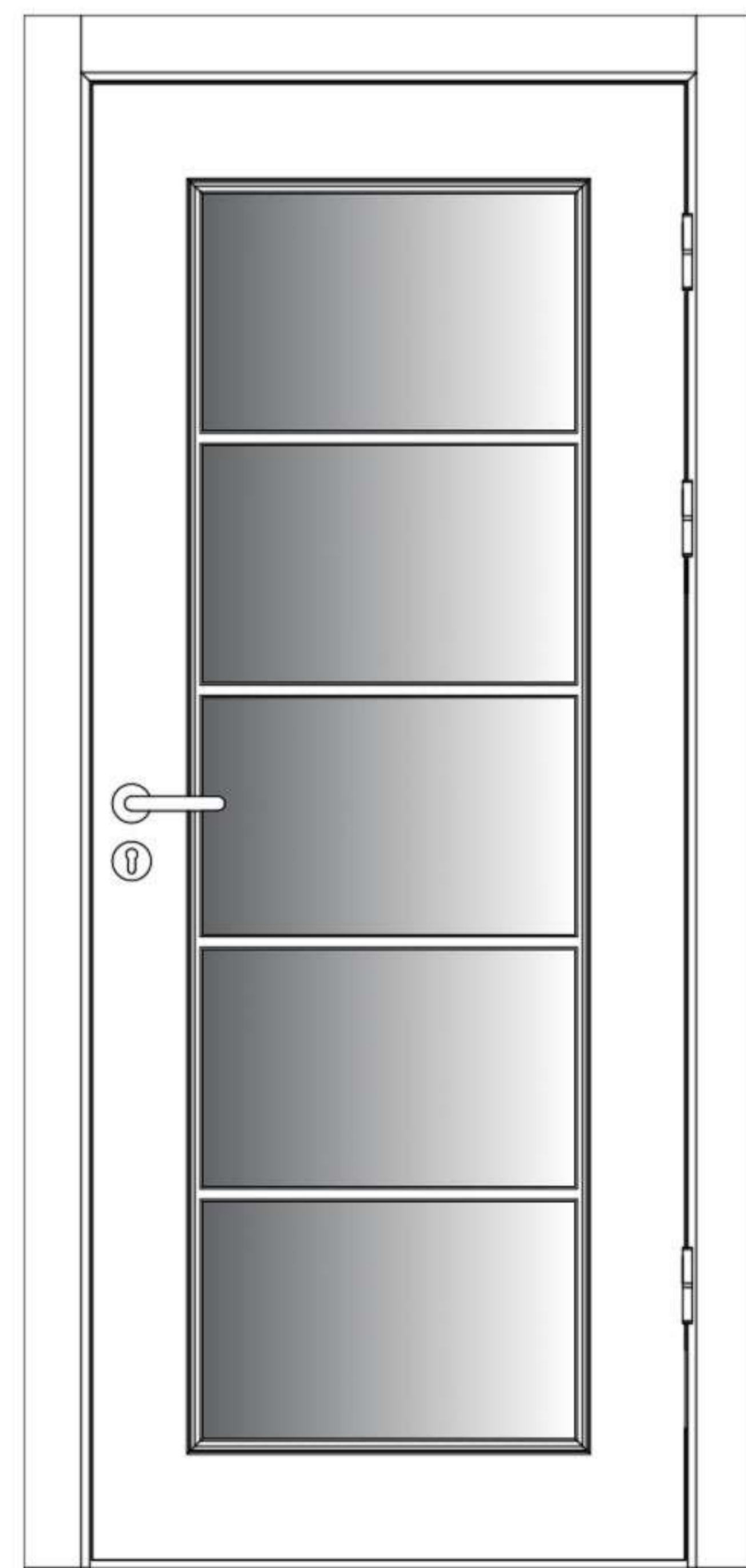

C108-G5

FRAME

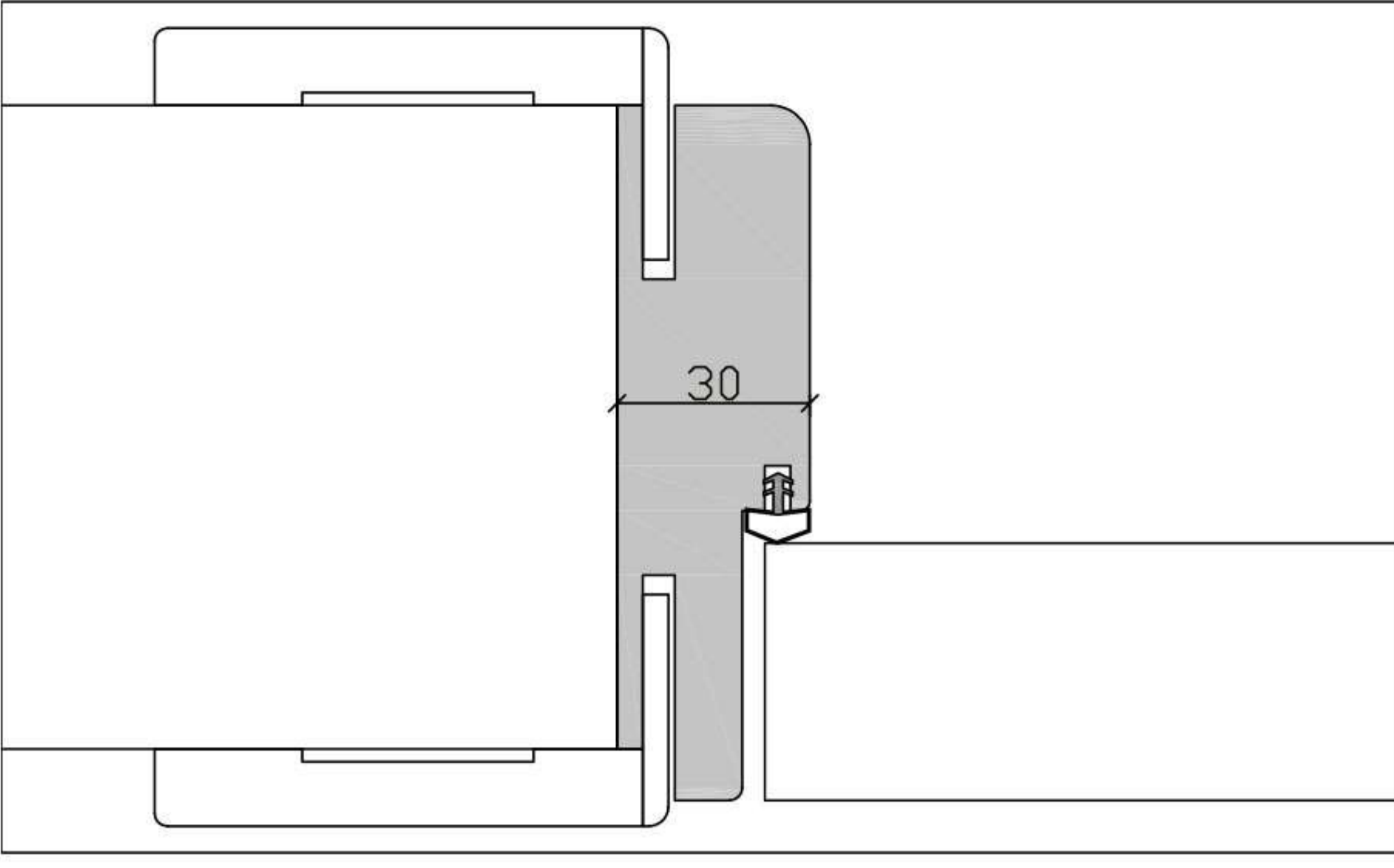

LEAF

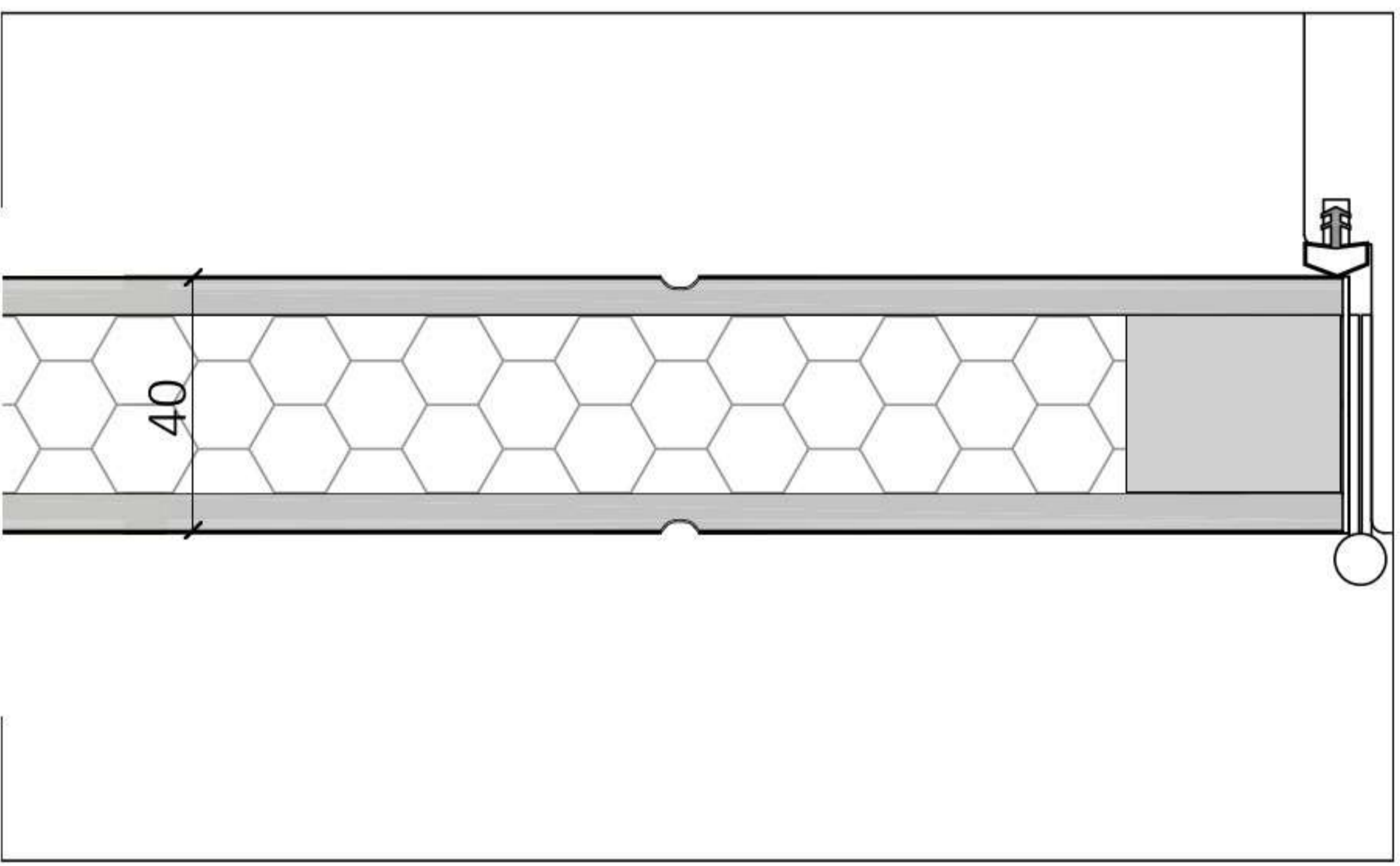

ARCHITRAVE

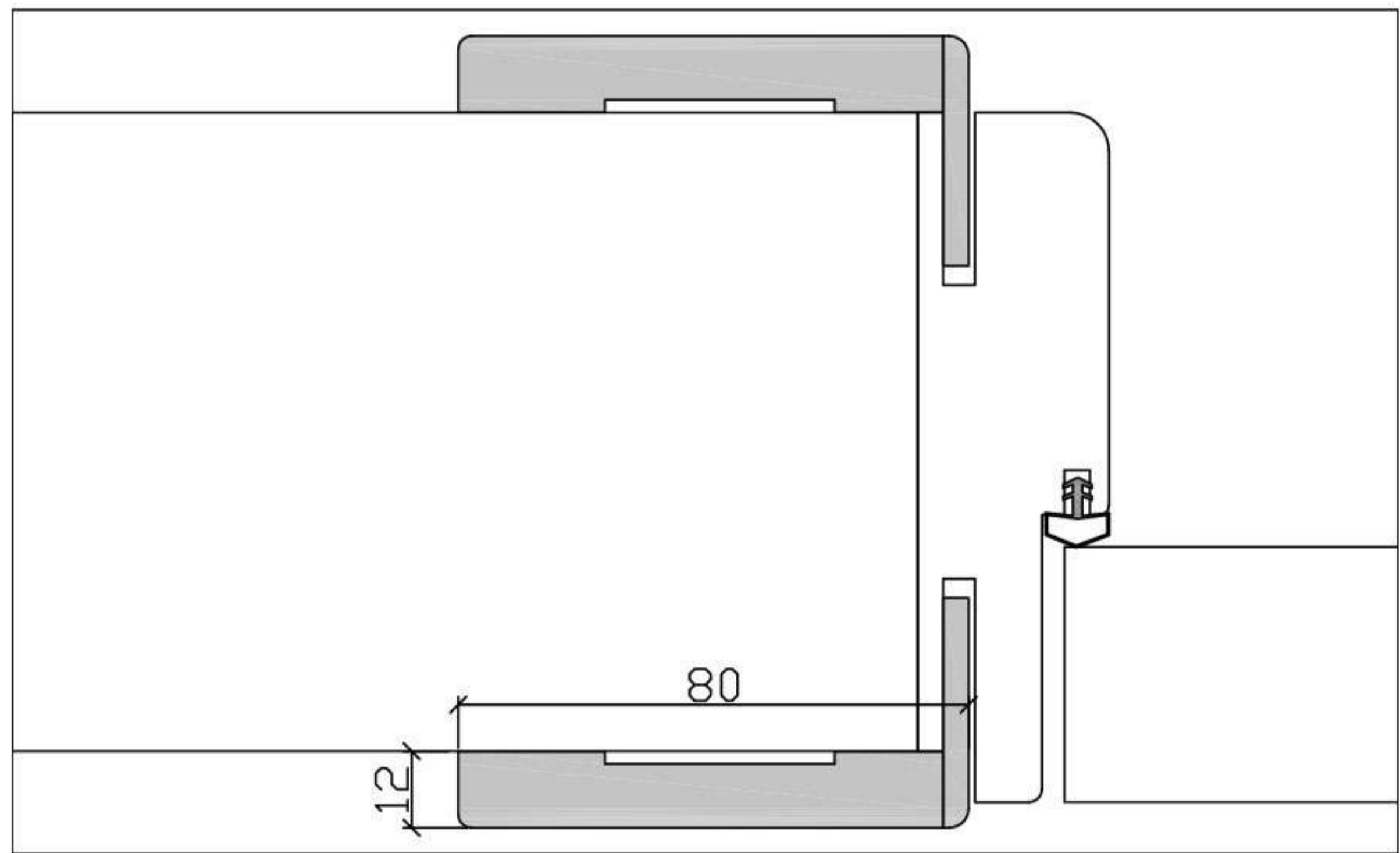

HARDWARE

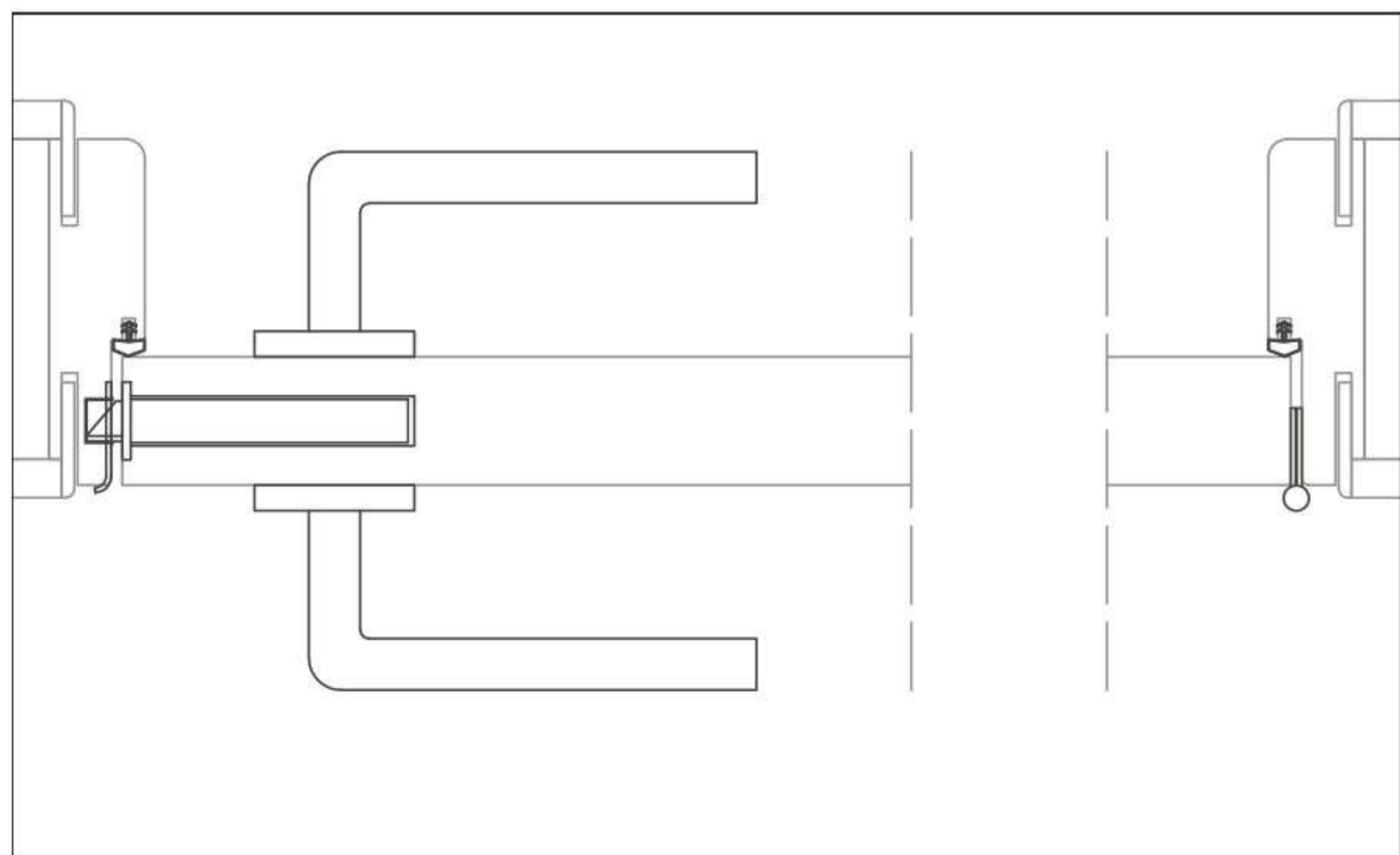

KASA

Aden serisi kapılarında, 30 mm MDF kasa standart olarak sunulur. Yüzeyler seçilen malzeme ve renkte tanımlanır. Kasa montaj öncesinde yerinde birleştirilir ve duvarla arasında kalan boşlukta 15 mm poliüretan dolgu malzemesi kullanılır. Duvar derinliğine göre farklı ölçü seçenekleri sunulmaktadır.

In Aden series doors, 30 mm MDF frame provided as standard. Surface defined with the selected material. Frame is assembled in the place before installation and the space between wall and frame fills with 15 mm polyurethane foam. Different size options are offered according to the depth of the wall.

KANAT

Tüm kapı modellerinde standart olarak 12mm kalınlığında 80 mm genişliğinde düz model mdf pervaz kullanılır. Pervaz yüzeyi kapı yüzeyi ile aynı malzeme/renk seçeneklerinden tercih edilir. Kapı üst başlık pervazı yan pervazlar arasında yerleştirilerek 90 derece köşe birleşim detayı sağlanmış olur.

Leafes are produced by fir wood door carcass with MDF surfaces on it and coated/painted with selected material. Total leaf thickness is 40 mm and side surfaces covered with edge band. Filler honeycomb is applied to the inner space.

PERVAZ

Tüm modellerde standart olarak 12 mm kalınlığında, 80 mm genişliğinde MDF pervaz çerçeveleri kullanılır. Yüzeyler seçilen malzemede tanımlanır. Pervazlar, kasa içerisine geçirilerek sabitlenir. Köşe pervaz 90° detayında birleştirilir. Yatay pervaz, dikey pervazların arasında konumlanır.

Architraves are standard in all models with 12 mm thickness and 80 mm MDF. Surfaces defined with the selected material. Arches slides inside of the frame and fixed. Upper corners joins together on 90° detail. Horizontal architrave is placed between vertical architraves.

AKSESUAR

Kapı temel elemanlarına ek olarak üçlü menteşe seti, kilit seti, kilit karşılığı ve model ile uyumlu fitil kapı seti ile birlikte gelir. Kol seti yuvası ise seçilen ilgili aralıktaki modele göre açılır ve ayrıca uygulanır. Opsiyonel olarak standart Aden kol setini de ürününüze ekleyebilirsiniz.

In addition to the basic elements of door, triple hinge set, lock counterpart and seal (compatible with door), comes with the product. Handle set slots opens according to model and applied separately. Optionally, you can add standard Aden handle set to your product.

018



L U X

A D

098



E N L U X



Geniş açıklıklı profil detayları ile birlikte zarif hatlara sahip bu modellerde kullanılan detaylar, klasik-modern tarzda göz alıcı bir görünüm elde edilmesini sağlar. Serilerin en detaylı profil açıklıklarına sahip modellerini barındırır.

In these models have stylish lines together with luxury profile details, provide an eye-catching look with classic-modern lines. This group includes the models with the most detailed profile gaps of the series.

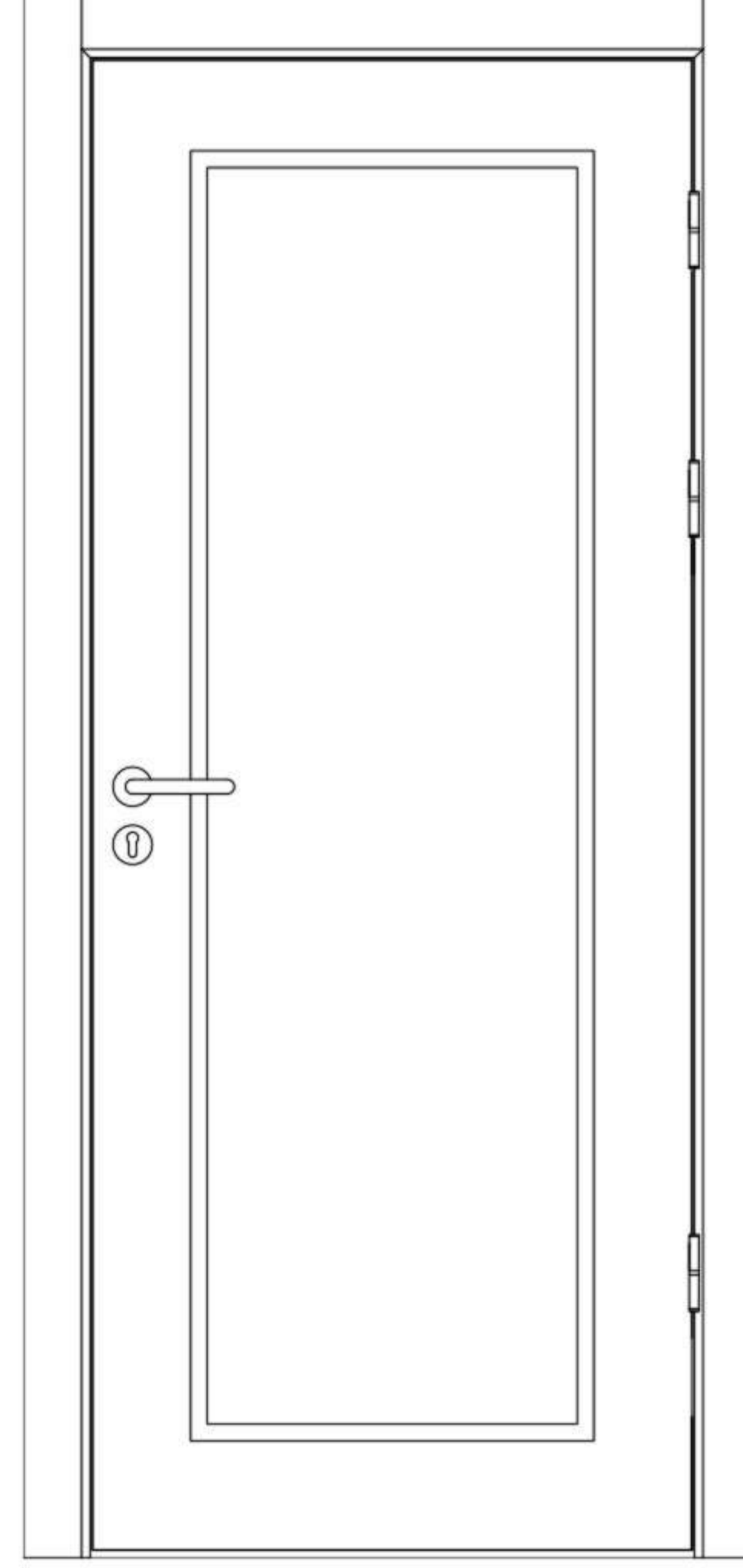

1 3 8



AÇIK MEŞE / LIGHT OAK
POLİMERİK / POLYMERIC



TİK / TEAK
POLİMERİK / POLYMERIC

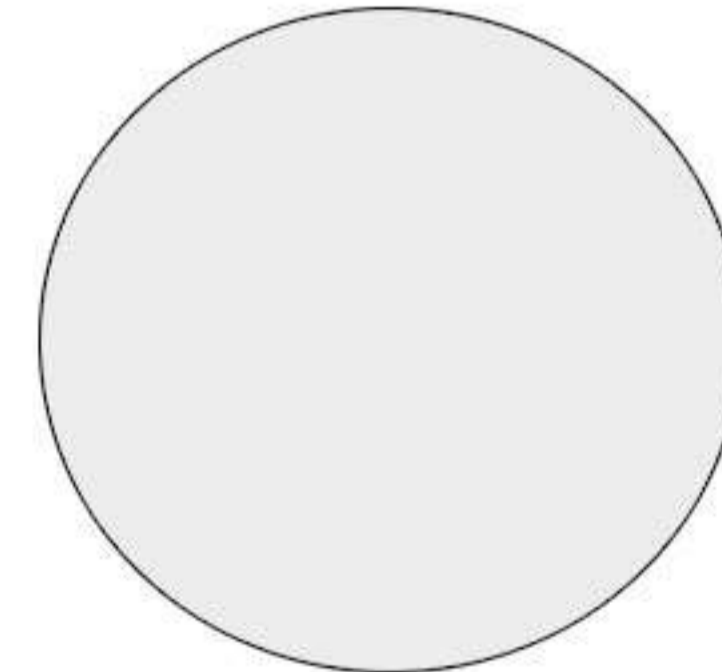

SOFT BEYAZ / SOFT WHITE
POLİMERİK / POLYMERIC

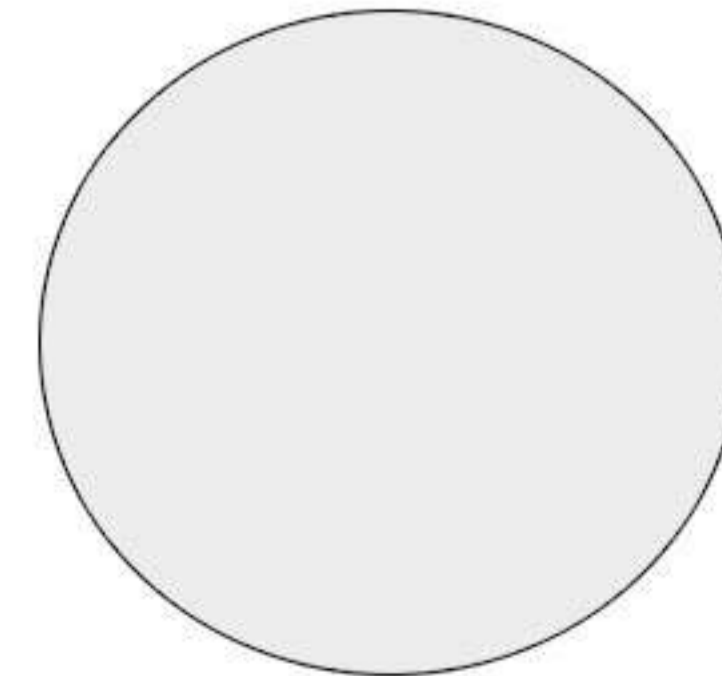

BEYAZ / WHITE
LAKE / LACQUER

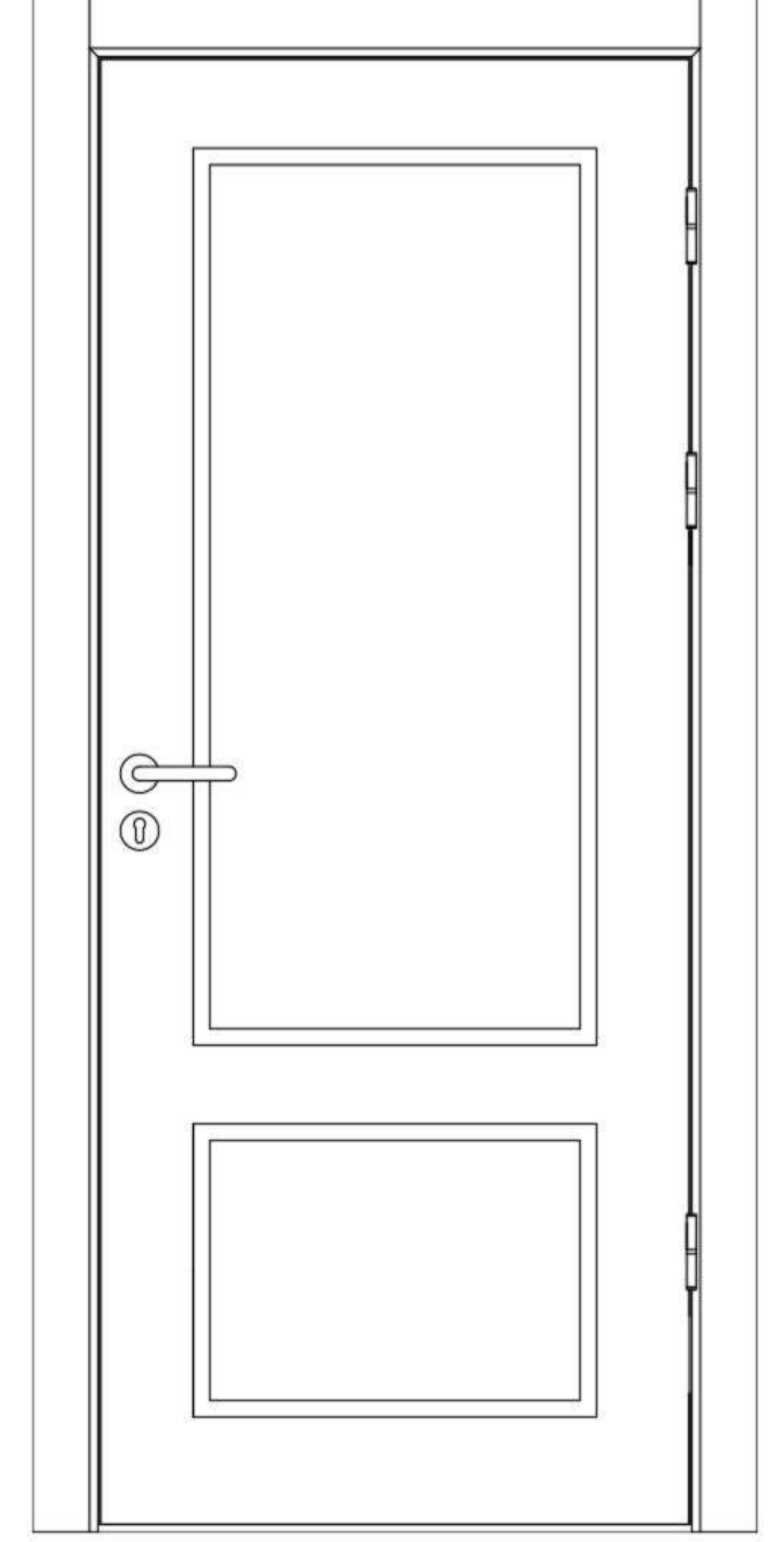

0 1 8



CINAR / PLANE
POLİMERİK / POLYMERIC

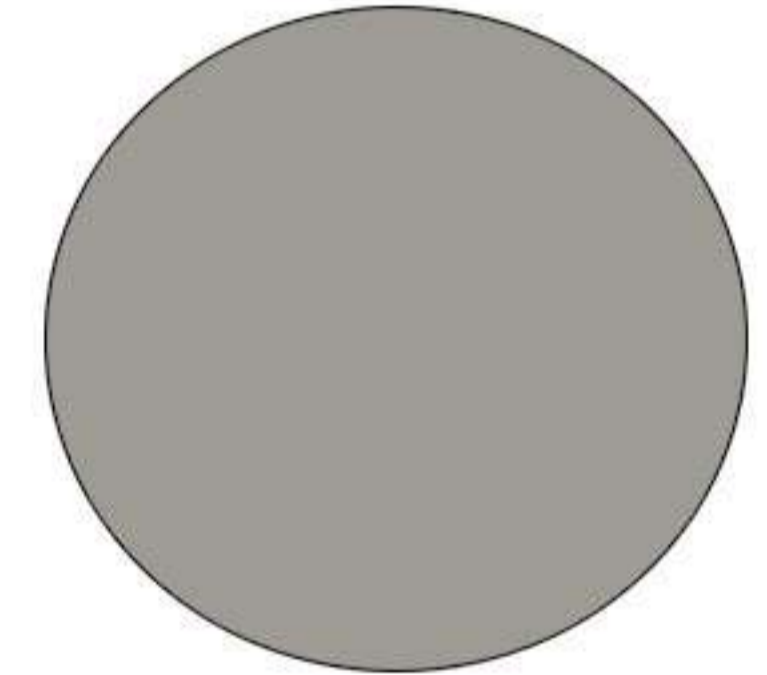

TAŞ GRİ / STONE GREY
POLİMERİK / POLYMERIC

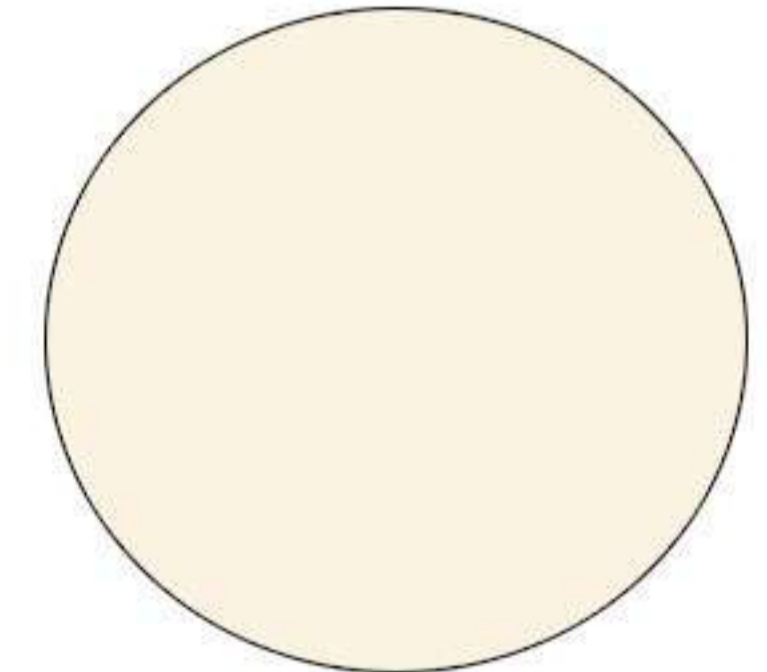

KREM / CREAM
POLİMERİK / POLYMERIC

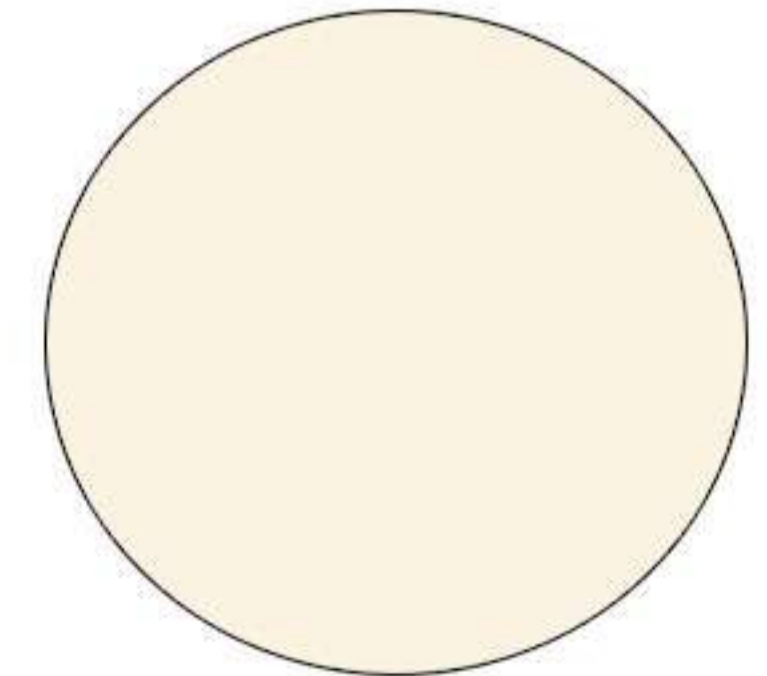

FİLDİŞİ / IVORY
LAKE / LACQUER

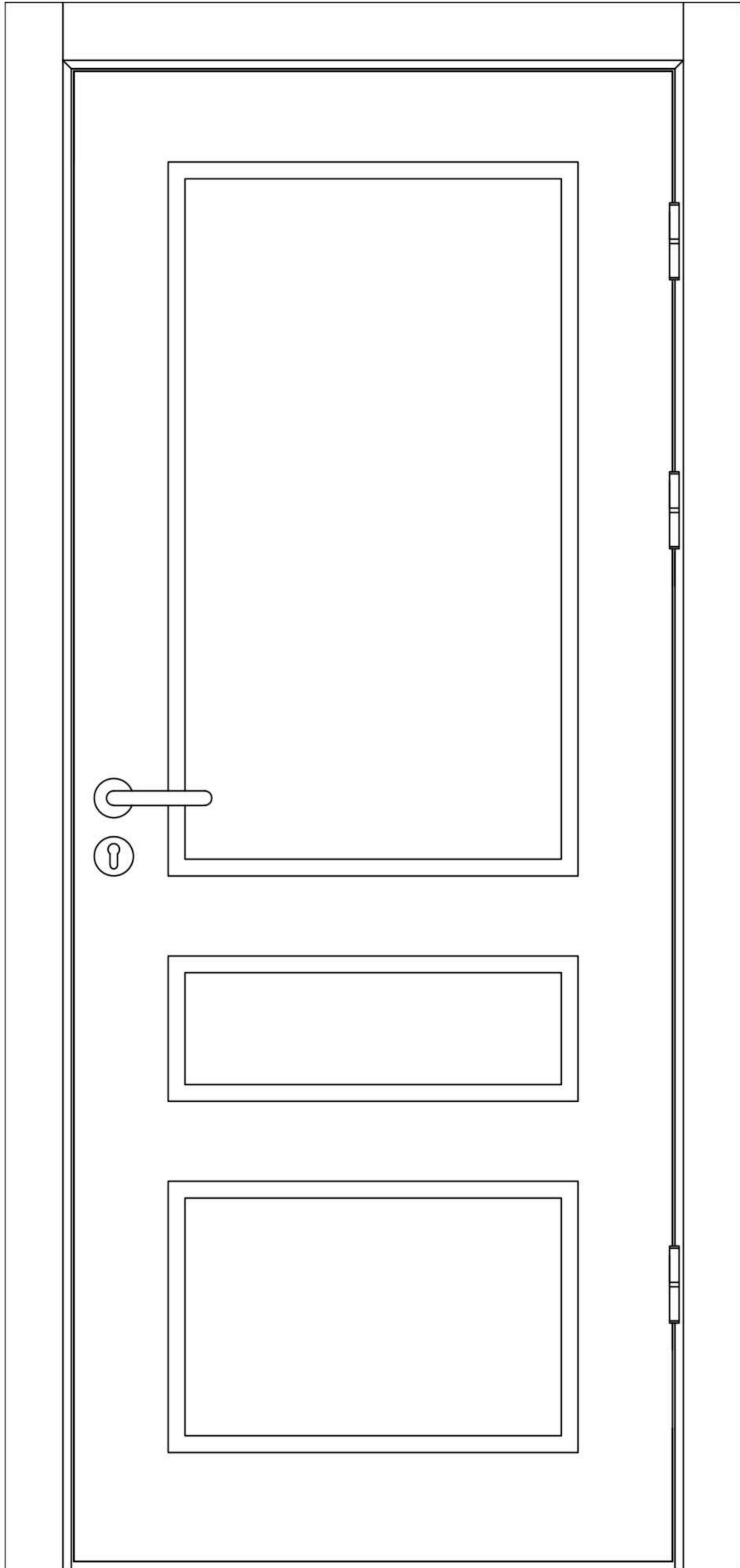

0 9 8

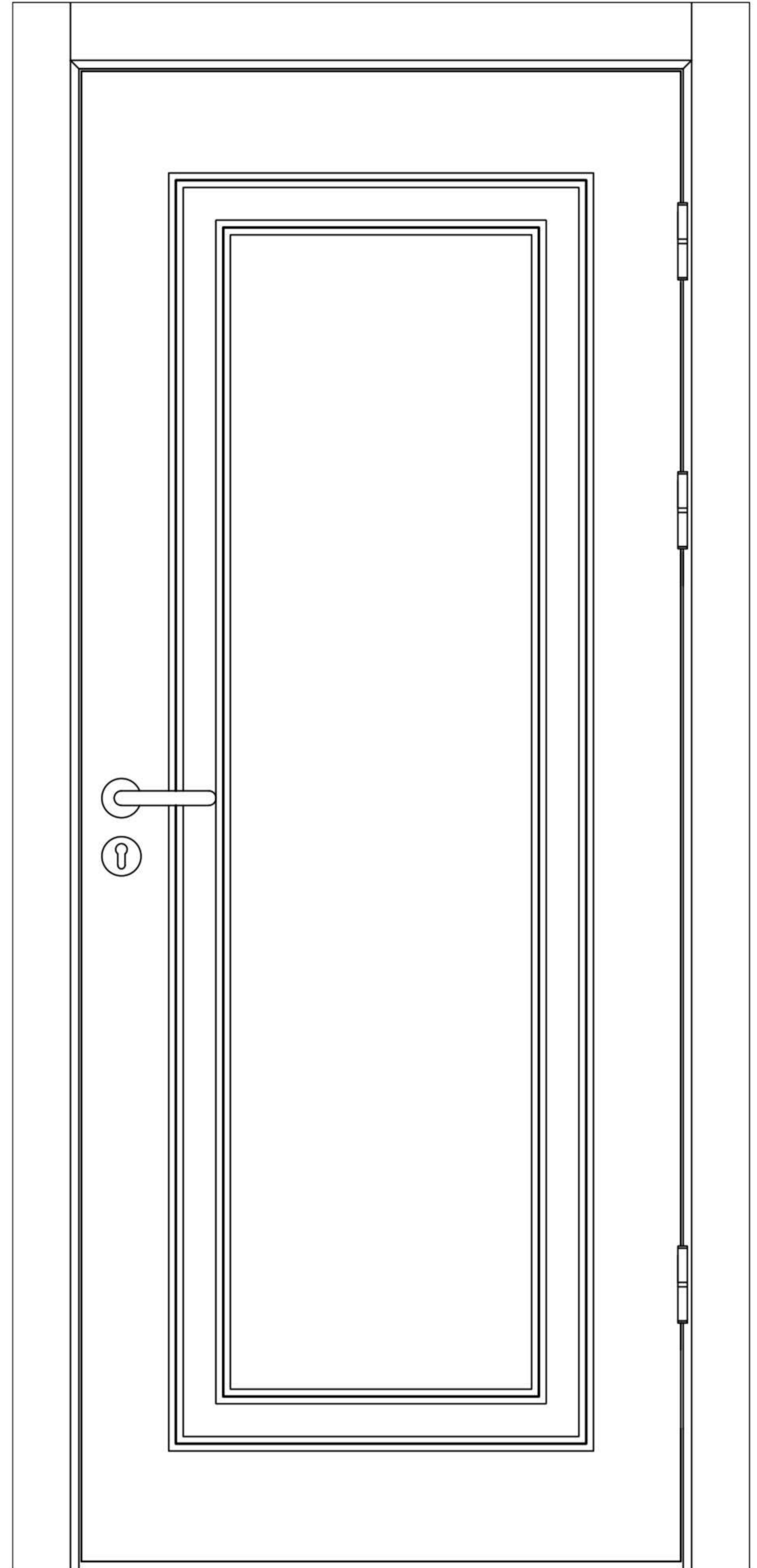

7 0 7

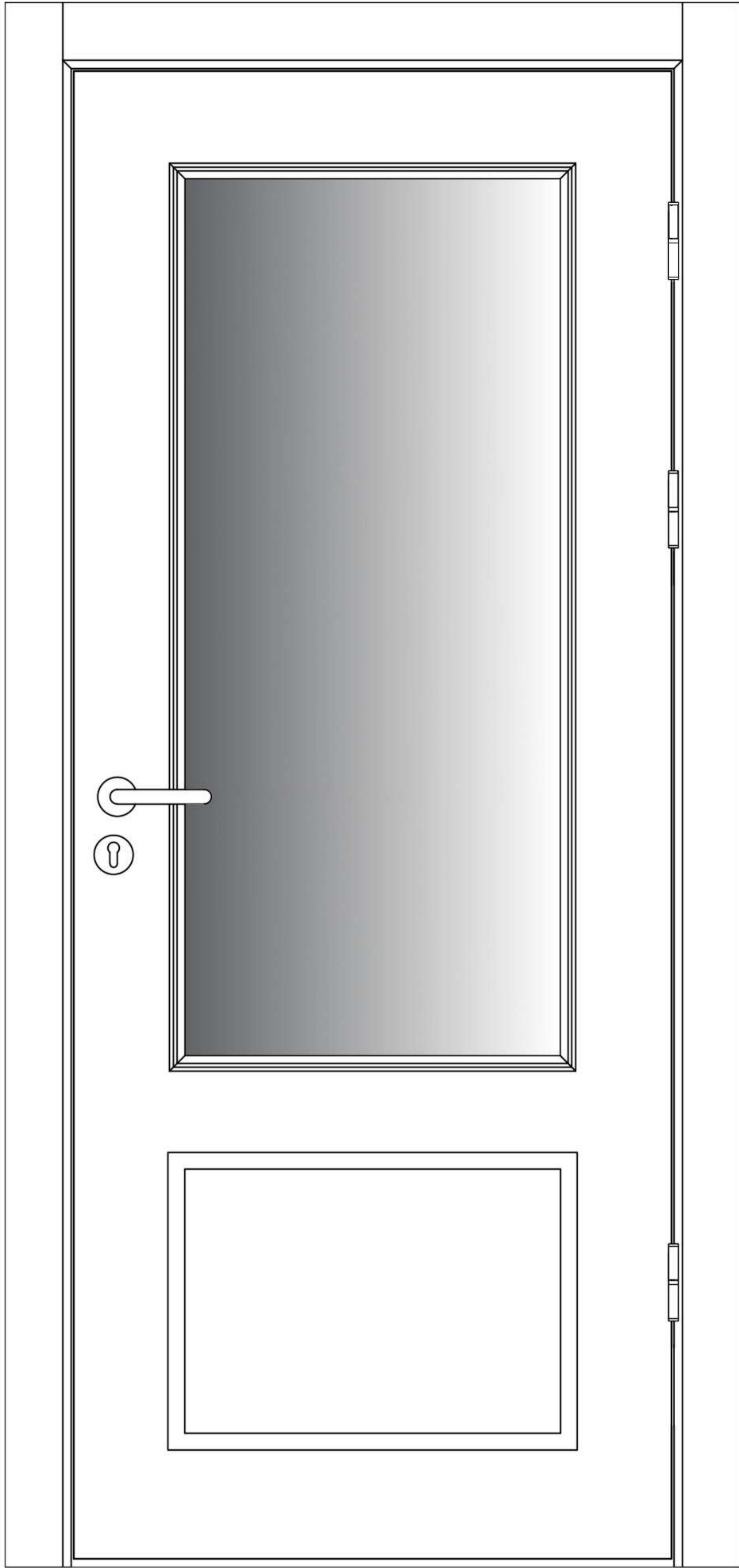

C018-G

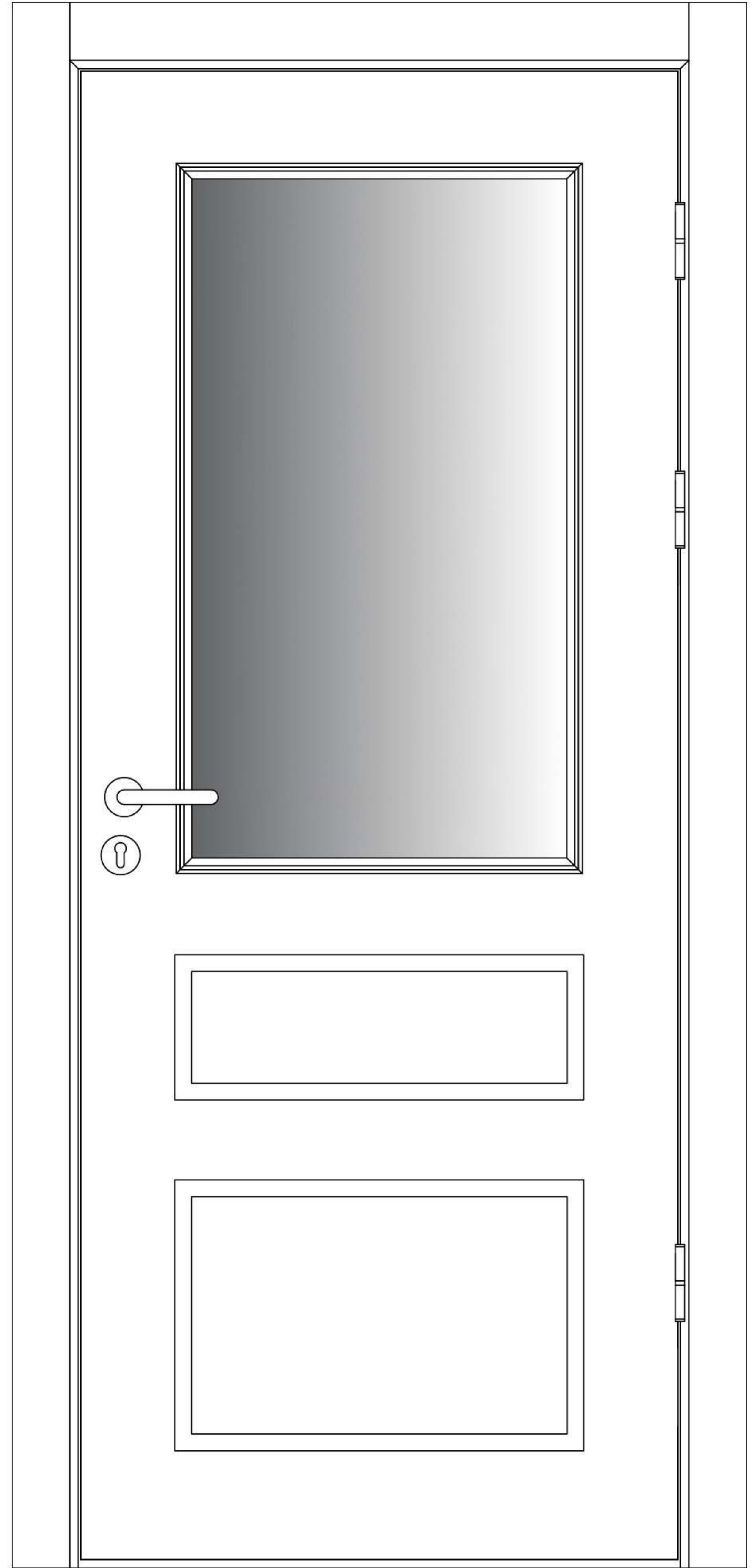

C098-G

FRAME

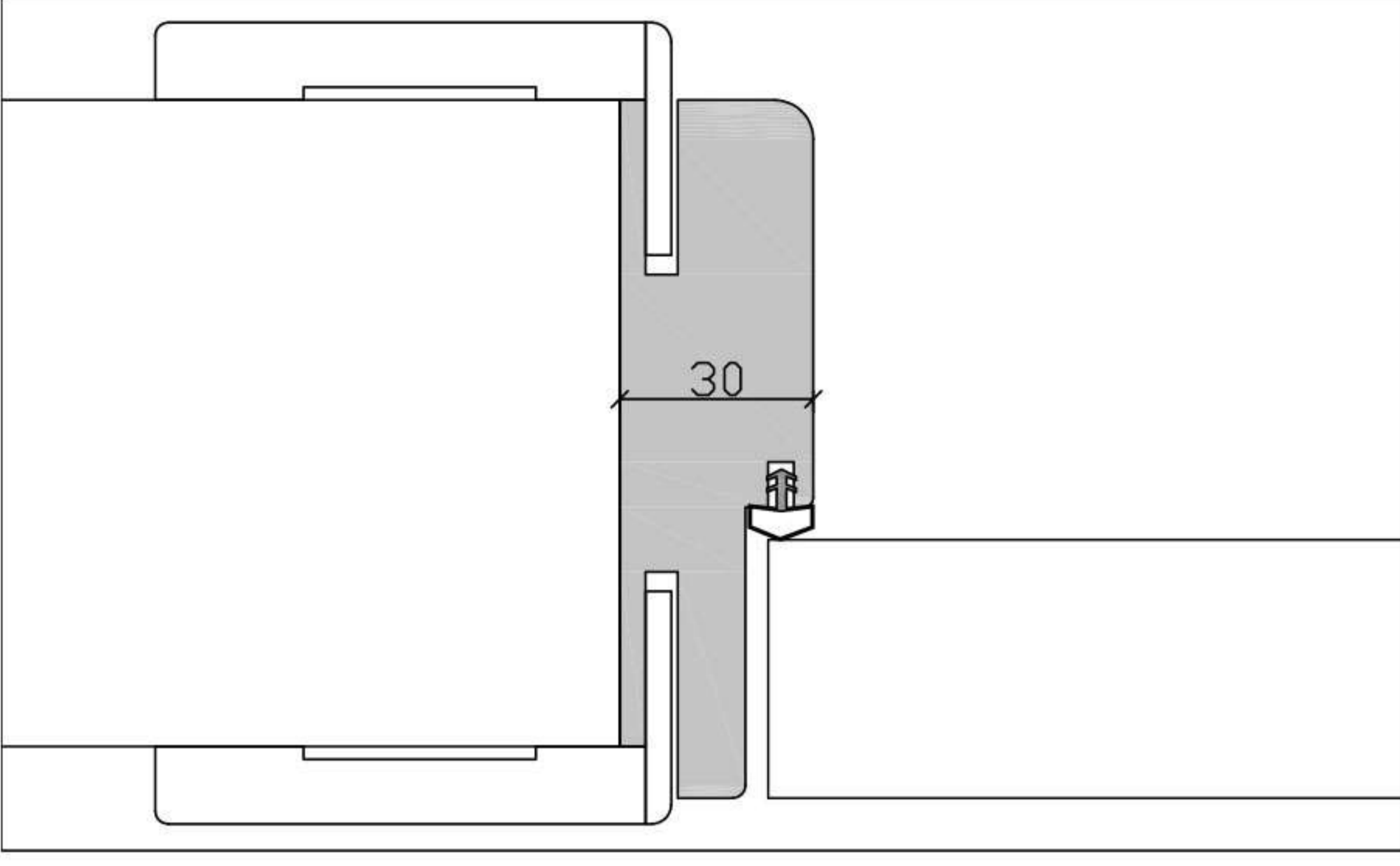

LEAF

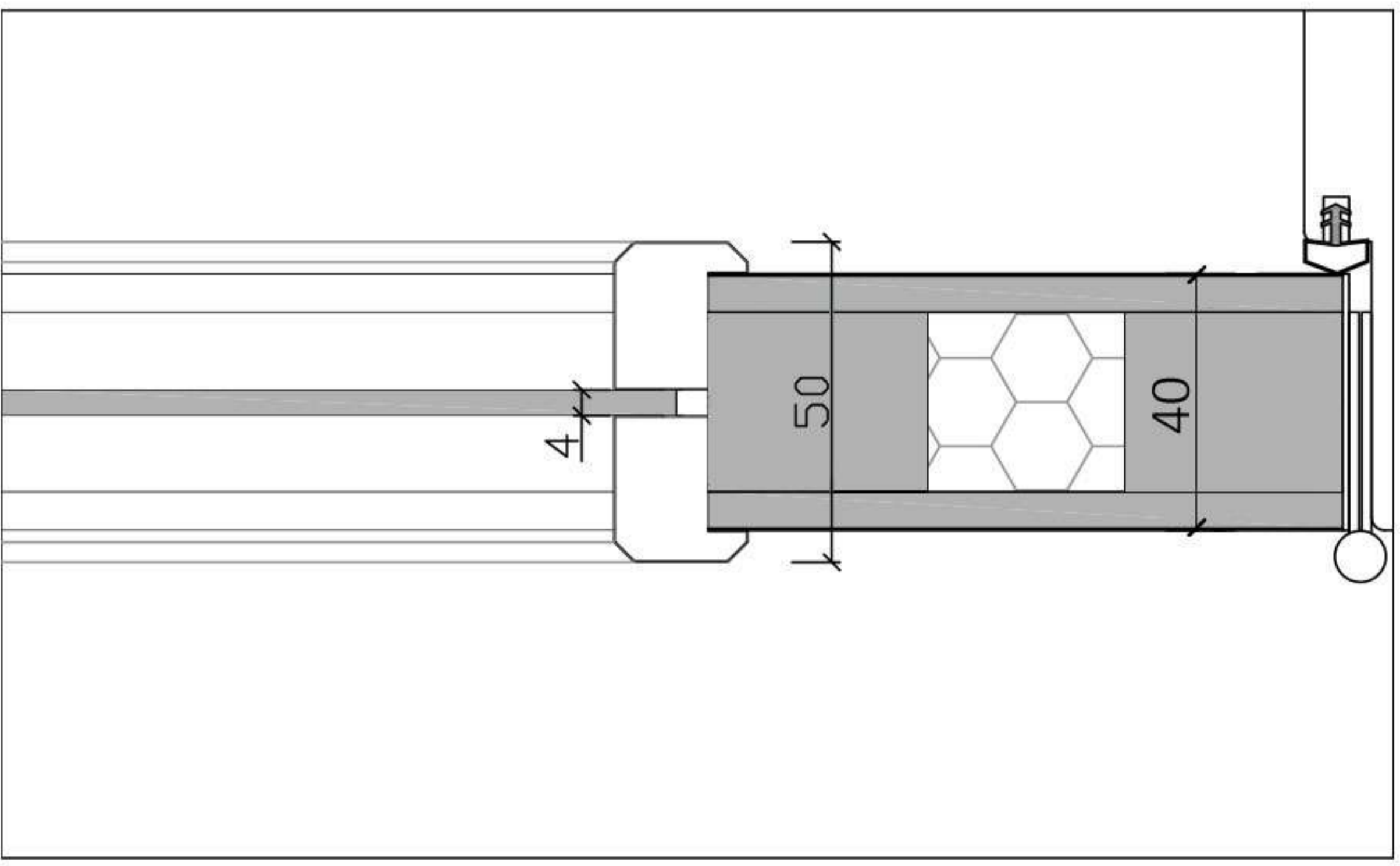

ARCHITRAVE

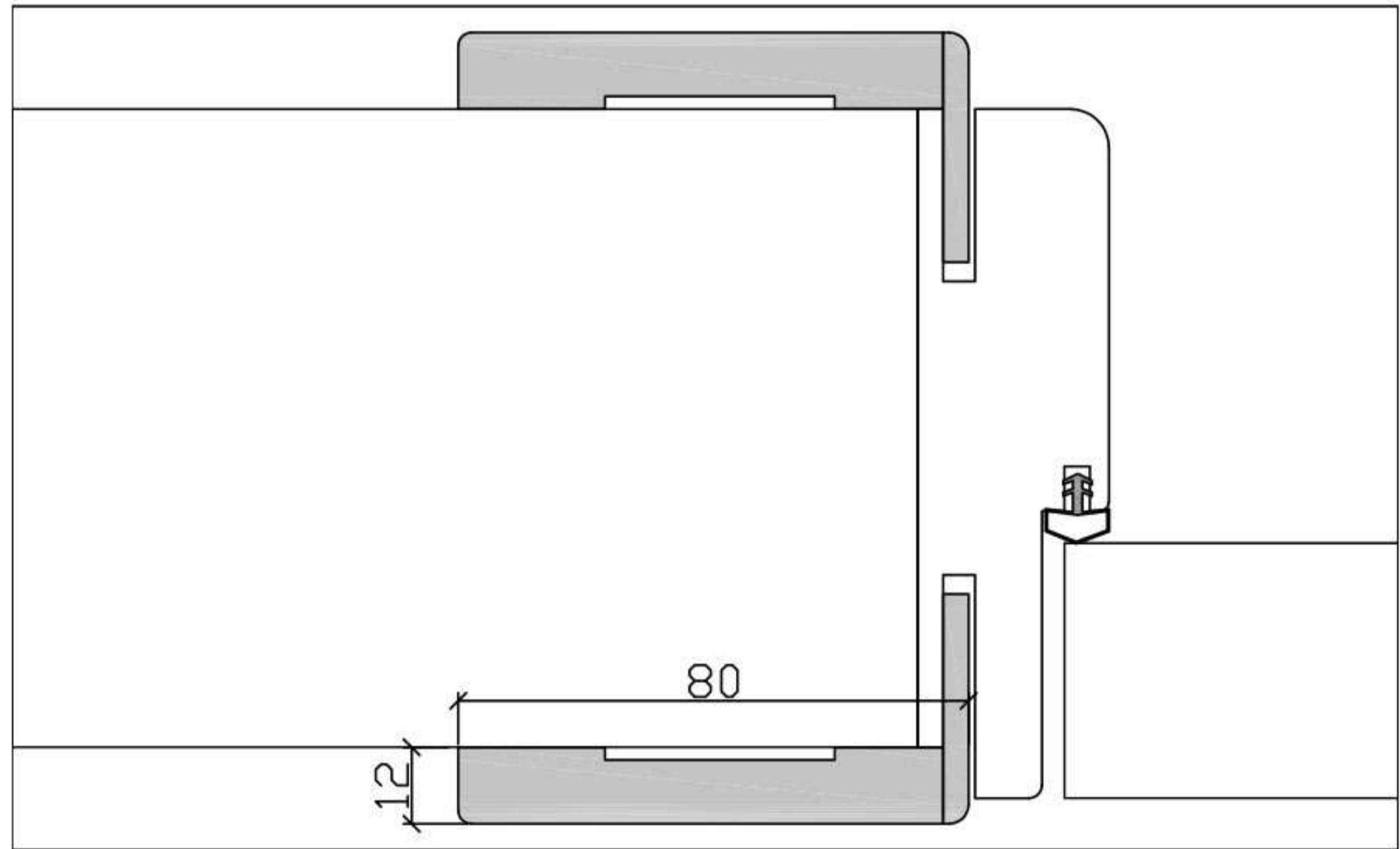

HARDWARE

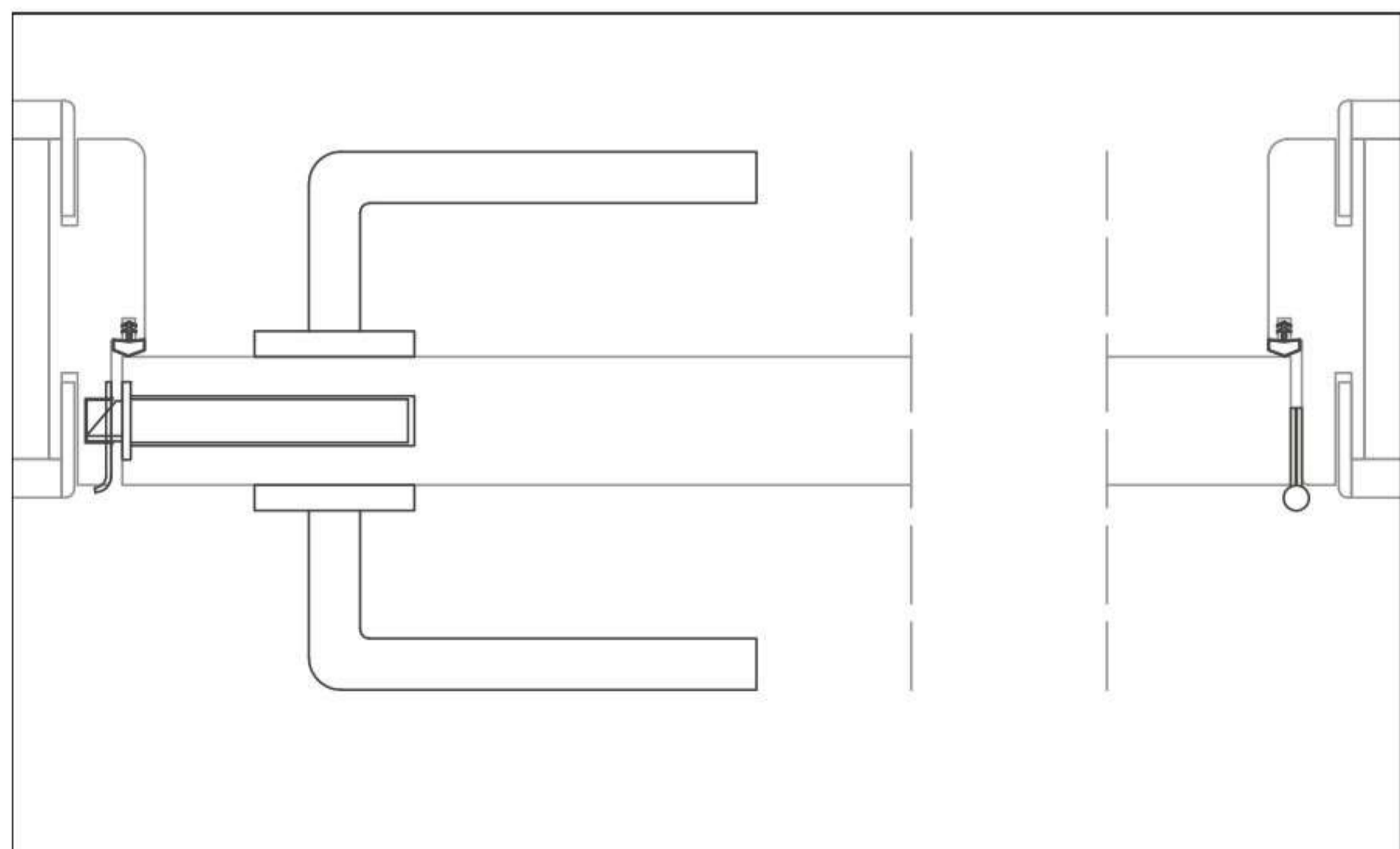

KASA

Aden serisi kapılarında, 30 mm MDF kasa standart olarak sunulur. Yüzeyler seçilen malzeme ve renkte tanımlanır. Kasa montaj öncesinde yerinde birleştirilir ve duvarla arasında kalan boşlukta 15 mm poliüretan dolgu malzemesi kullanılır. Duvar derinliğine göre farklı ölçü seçenekleri sunulmaktadır.

In Aden series doors, 30 mm MDF frame provided as standard. Surface defined with the selected material. Frame is assembled in the place before installation and the space between wall and frame fills with 15 mm polyurethane foam. Different size options are offered according to the depth of the wall.

KANAT

Tüm kapı modellerinde standart olarak 12mm kalınlığında 80 mm genişliğinde düz model mdf pervaz kullanılır. Pervaz yüzeyi kapı yüzeyi ile aynı malzeme/renk seçeneklerinden tercih edilir. Kapı üst başlık pervazı yan pervazlar arasında yerleştirilerek 90 derece köşe birleşim detayı sağlanmış olur.

Leafes are produced by fir wood door carcass with MDF surfaces on it and coated/painted with selected material. Total leaf thickness is 40 mm and side surfaces covered with edge band. Filler honeycomb is applied to the inner space.

PERVAZ

Tüm modellerde standart olarak 12 mm kalınlığında, 80 mm genişliğinde MDF pervaz çerçeveleri kullanılır. Yüzeyler seçilen malzemede tanımlanır. Pervazlar, kasa içerisine geçirilerek sabitlenir. Köşe pervaz 90° detayında birleştirilir. Yatay pervaz, dikey pervazların arasında konumlanır.

Architraves are standard in all models with 12 mm thickness and 80 mm MDF. Surfaces defined with the selected material. Arches slides inside of the frame and fixed. Upper corners joins together on 90° detail. Horizontal architrave is placed between vertical architraves.

AKSESUAR

Kapı temel elemanlarına ek olarak üçlü menteşe seti, kilit seti, kilit karşılığı ve model ile uyumlu fitil kapı seti ile birlikte gelir. Kol seti yuvası ise seçilen ilgili aralıktaki modele göre açılır ve ayrıca uygulanır. Opsiyonel olarak standart Aden kol setini de ürününüze ekleyebilirsiniz.

In addition to the basic elements of door, triple hinge set, lock counterpart and seal (compatible with door), comes with the product. Handle set slots opens according to model and applied separately. Optionally, you can add standard Aden handle set to your product.



C108-G5
PONTE



707
LUX



710
PONTE



420
PONTE

ÖLÇÜ KILAVUZU

<p>EN WIDTH (CM)</p> <p>70</p> <p>80</p> <p>90</p>	
<p>BOY HEIGHT (CM)</p> <p>205</p> <p>210</p>	
<p>KASA FRAME (CM)</p> <p>10 (11-12)</p> <p>13 (14-15)</p> <p>16 (17-18)</p> <p>19 (20-21)</p>	

EN
WIDTH
(CM)

130

Yavru K.
One &
Half L.

180

Çift K.
Double L.

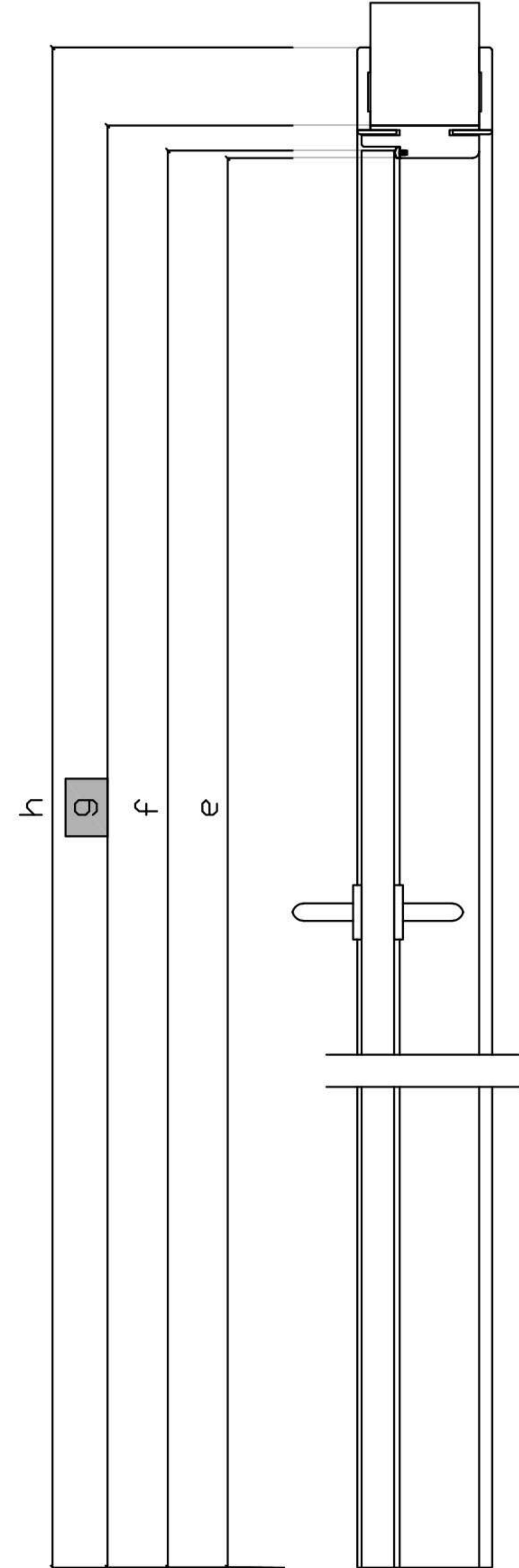
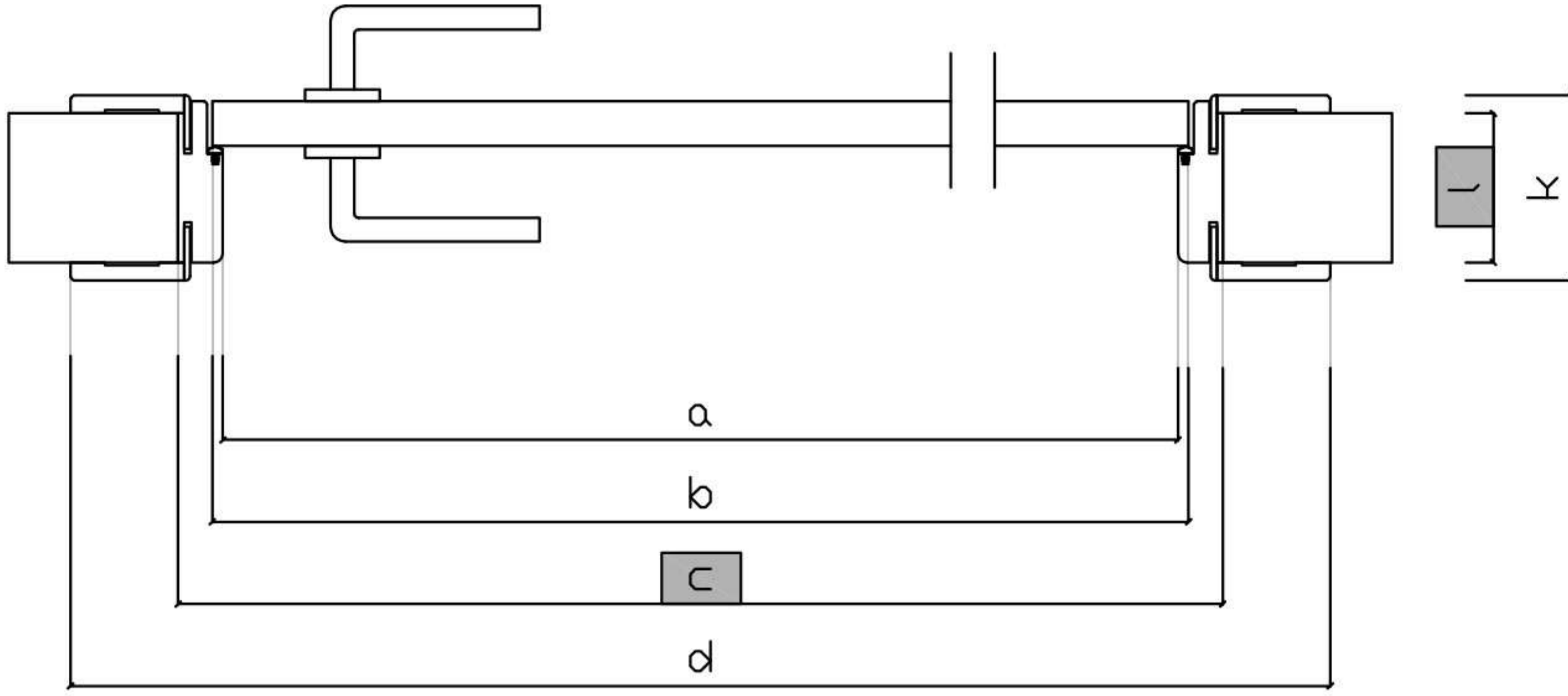
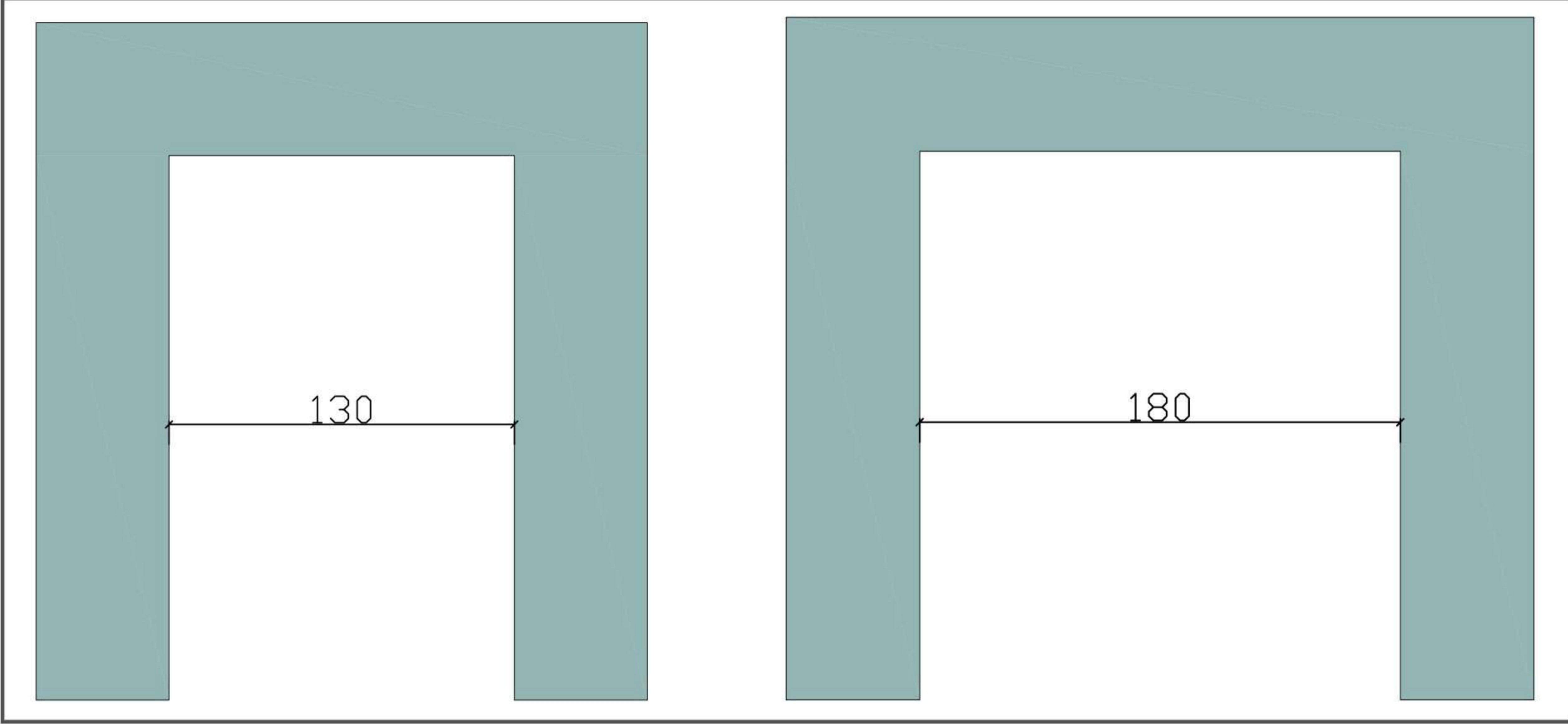

a-e Geçiş / Pass c-g Boşluk / Space l Derinlik / Depth
b-f Kanat / Leaf d-h Toplam / Total k T. Derinlik / T. Depth

Tip/Type	a	b	c	d	e	f	g	h	l	k
-	610	624	700	814	2005	2020	2050	2107	100	124
	710	724	800	914	2055	2070	2100	2157		
	810	824	900	1014	2005	2020	2050	2107		
-	1210	1224	1300	1414	2055	2070	2100	2157	130	154
	1710	1724	1800	1914	2005	2020	2050	2107	160	184
-	1710	1724	1800	1914	2005	2020	2050	2107		
					2055	2070	2100	2157		



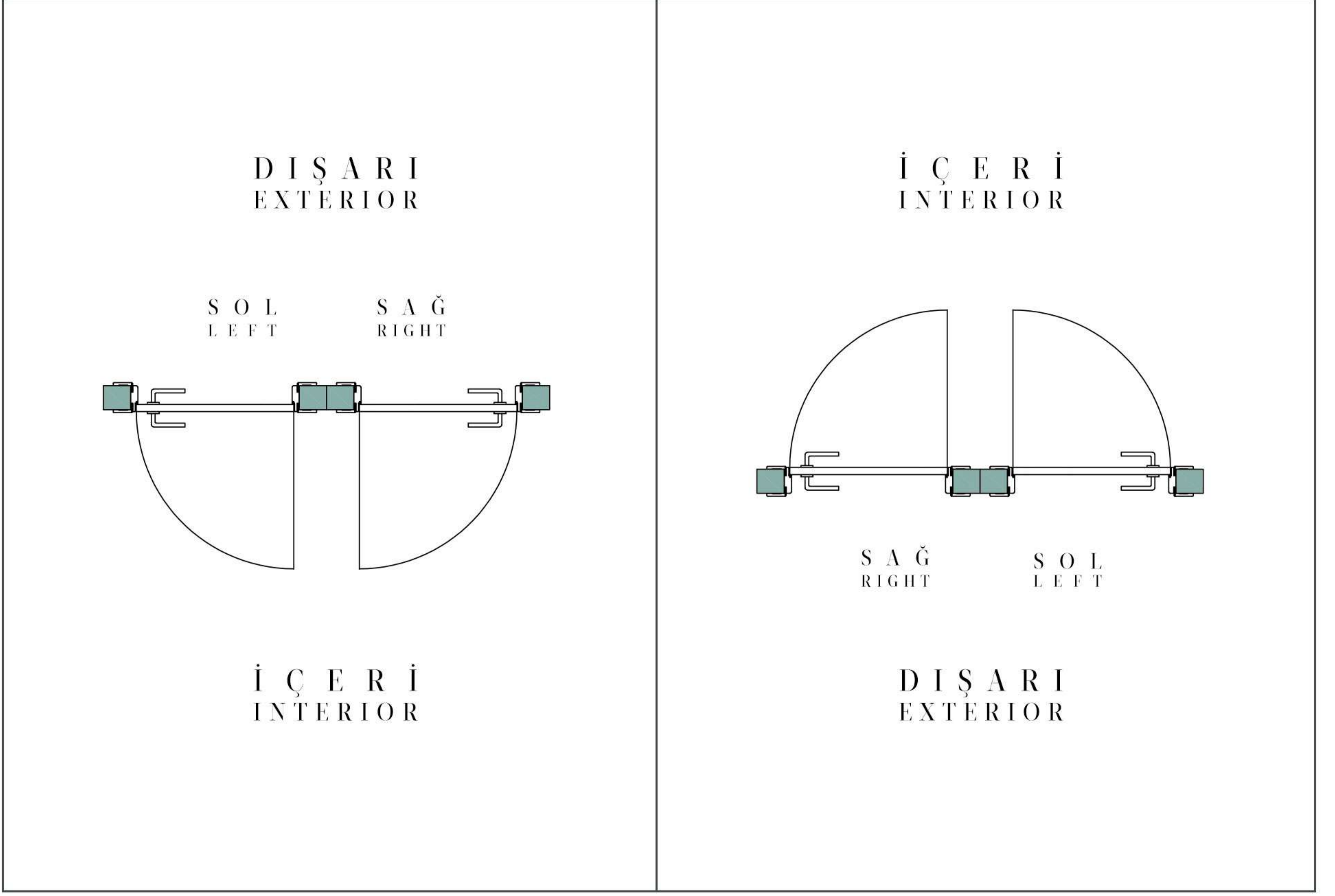

DİĞER ÖLÇÜLER / OTHER MEASURES

KAPI YÖNÜ / DOOR DIRECTION



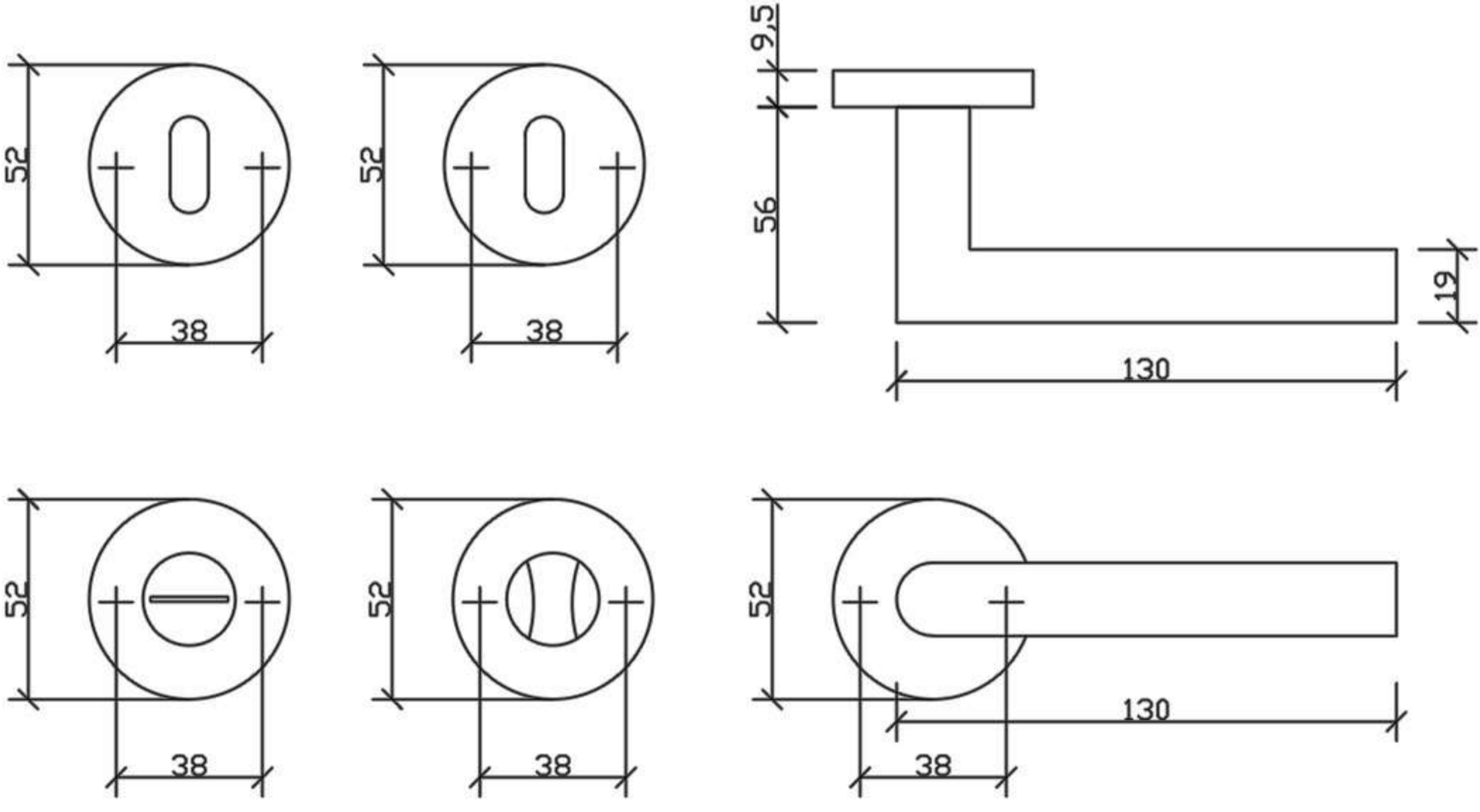

DONANIM / HARDWARE

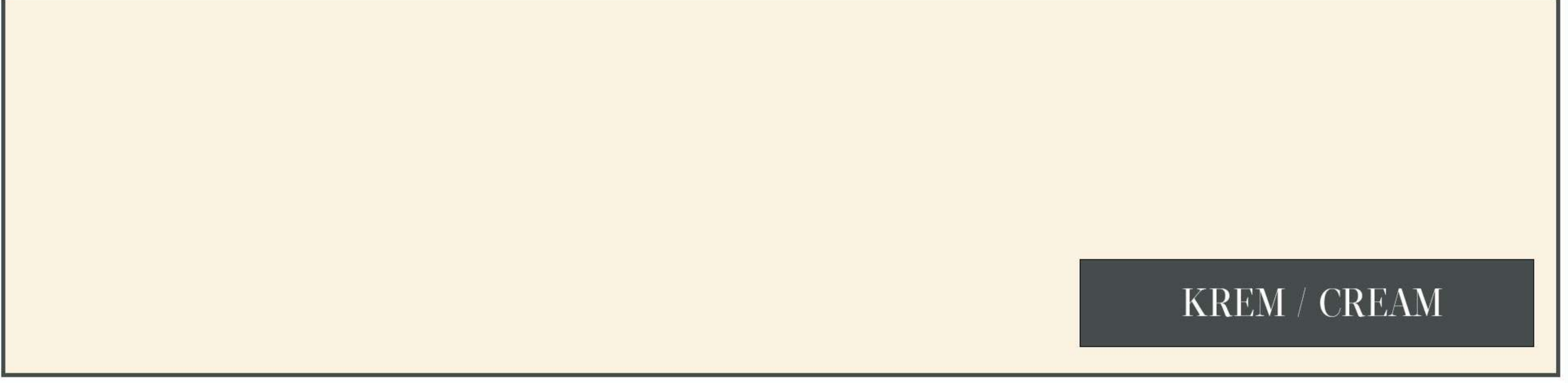
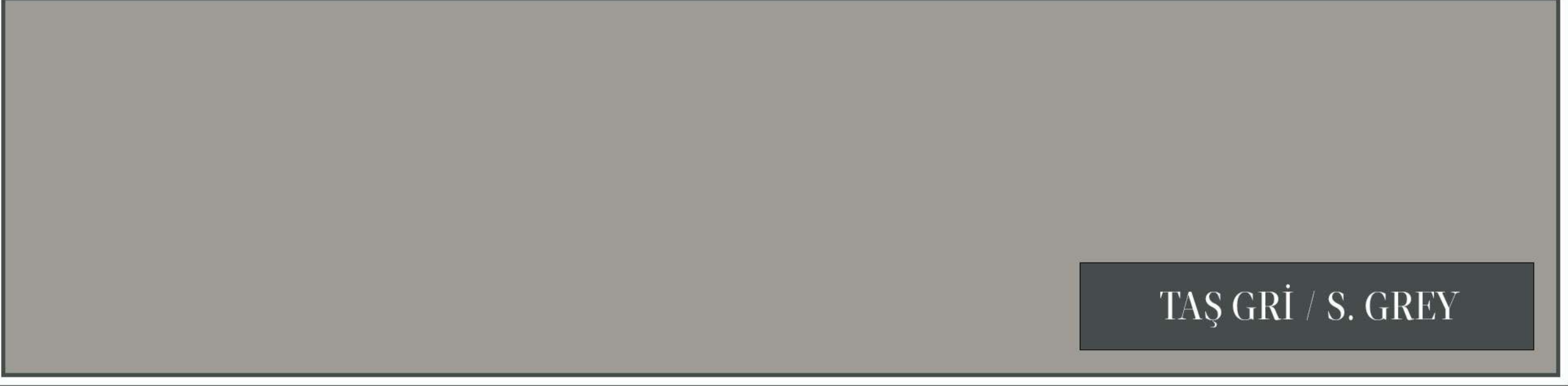

AÇIKLAMA DESCRIPTION	TEKNİK TECHNIC	BANYO TİPİ BATHROOM TYPE	S. ODA TİPİ S. ROOM TYPE
<p>Paslanmaz çelik Aden kol setleri, silindirik yapısı ile konforlu ve zarif, minimal tasarımı sayesinde de tüm Aden modelleri ile uyumludur. (Model Kodu : KK402)</p> <p>Stainless steel Aden handle sets are compatible with all Aden models with its minimal design, comfortable with its cylindrical structure. (Model Code : KK402)</p>			
			
<p style="text-align: center;">ADEN STANDART KOL SETİ / ADEN STANDARD HANDLE SET</p>			

RENK PALETİ

POLYMERIC Polimerik Lamine Renk Kaplama	Polymeric Laminated Color Coating		S. BEYAZ / S. WHITE
		KREM / CREAM	
		TAŞ GRİ / S. GREY	

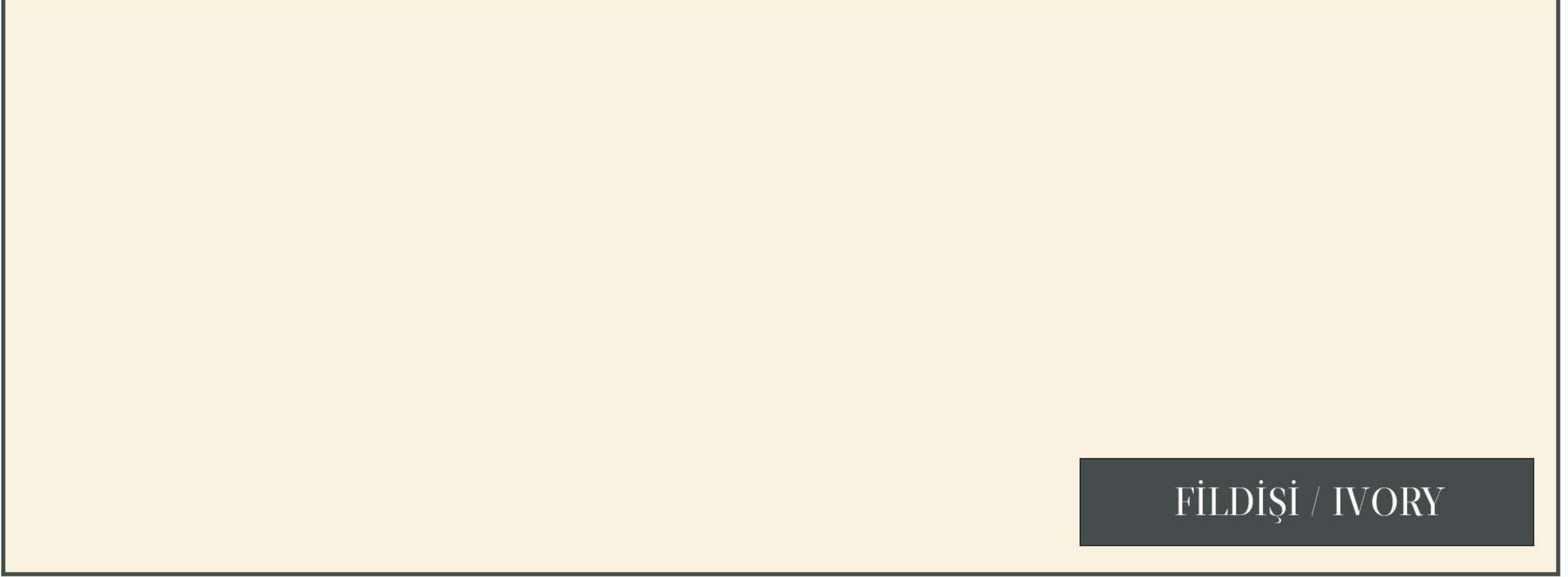
LACQUER İpek Mat Lake Boya	Silk Matte Lacquer Paint		BEYAZ / WHITE
		FİLDİŞİ / IVORY	

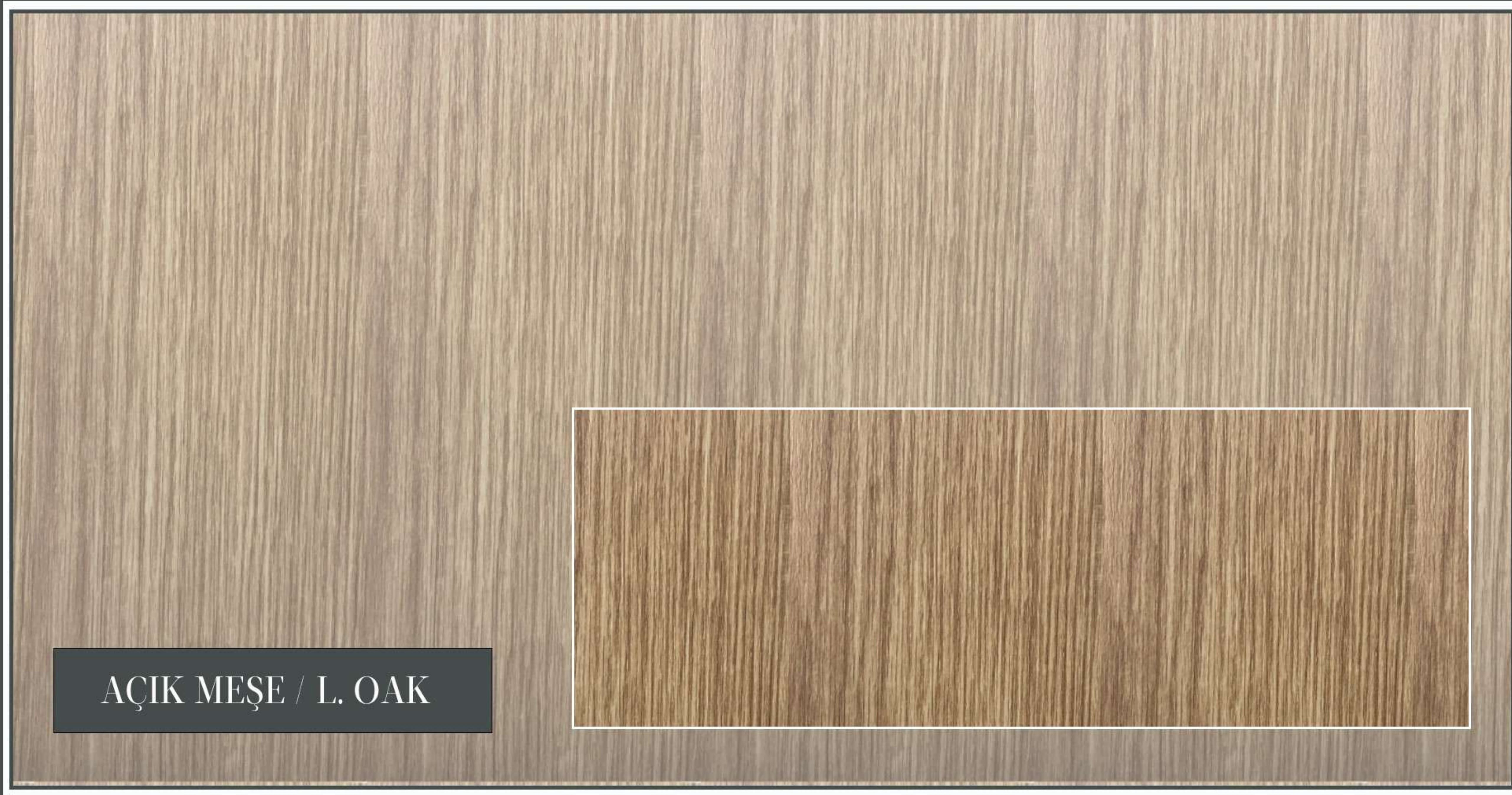

AÇIK MEŞE / L. OAK

Polymeric
Laminated Wood Coating

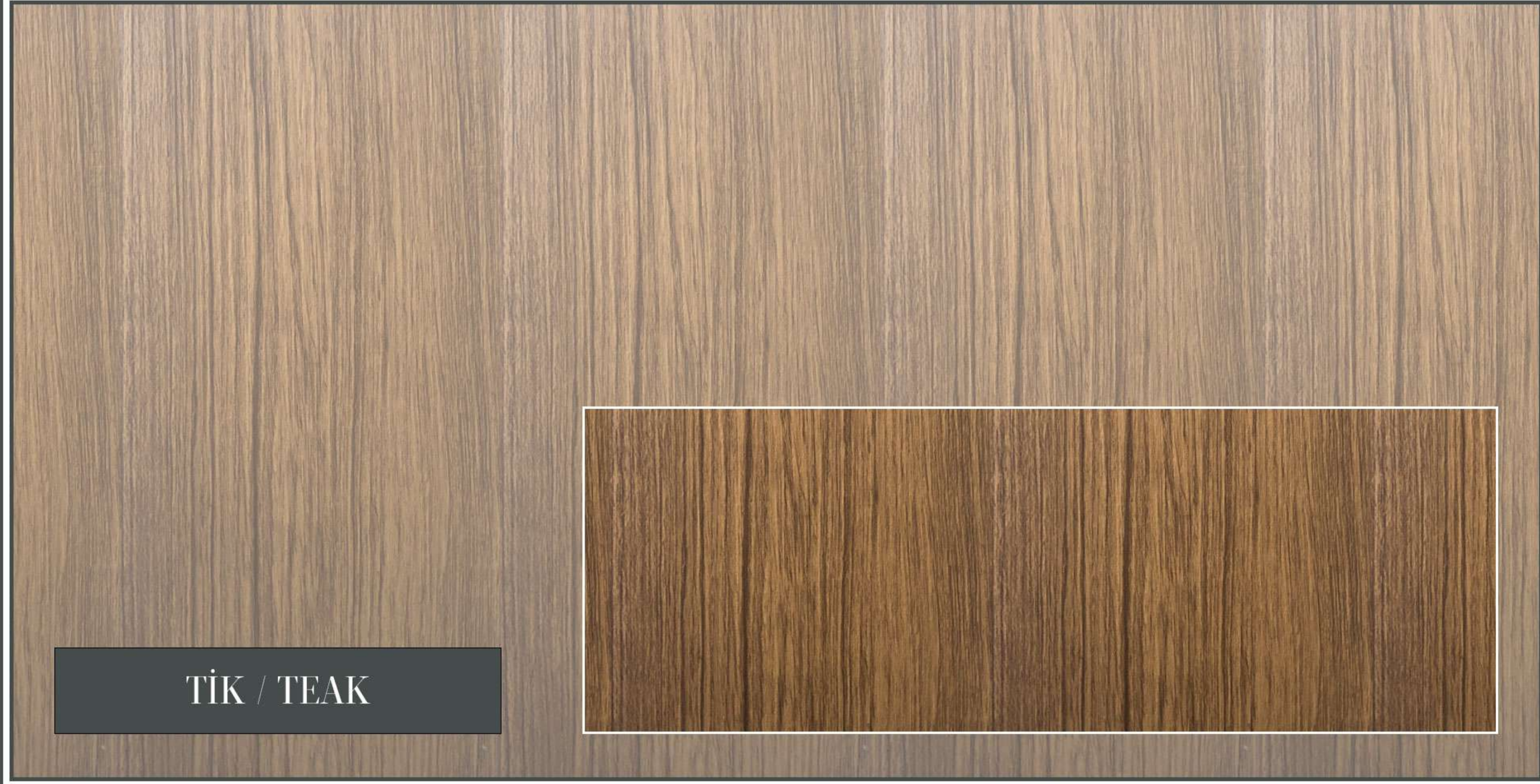

TİK / TEAK

POLYMERIC

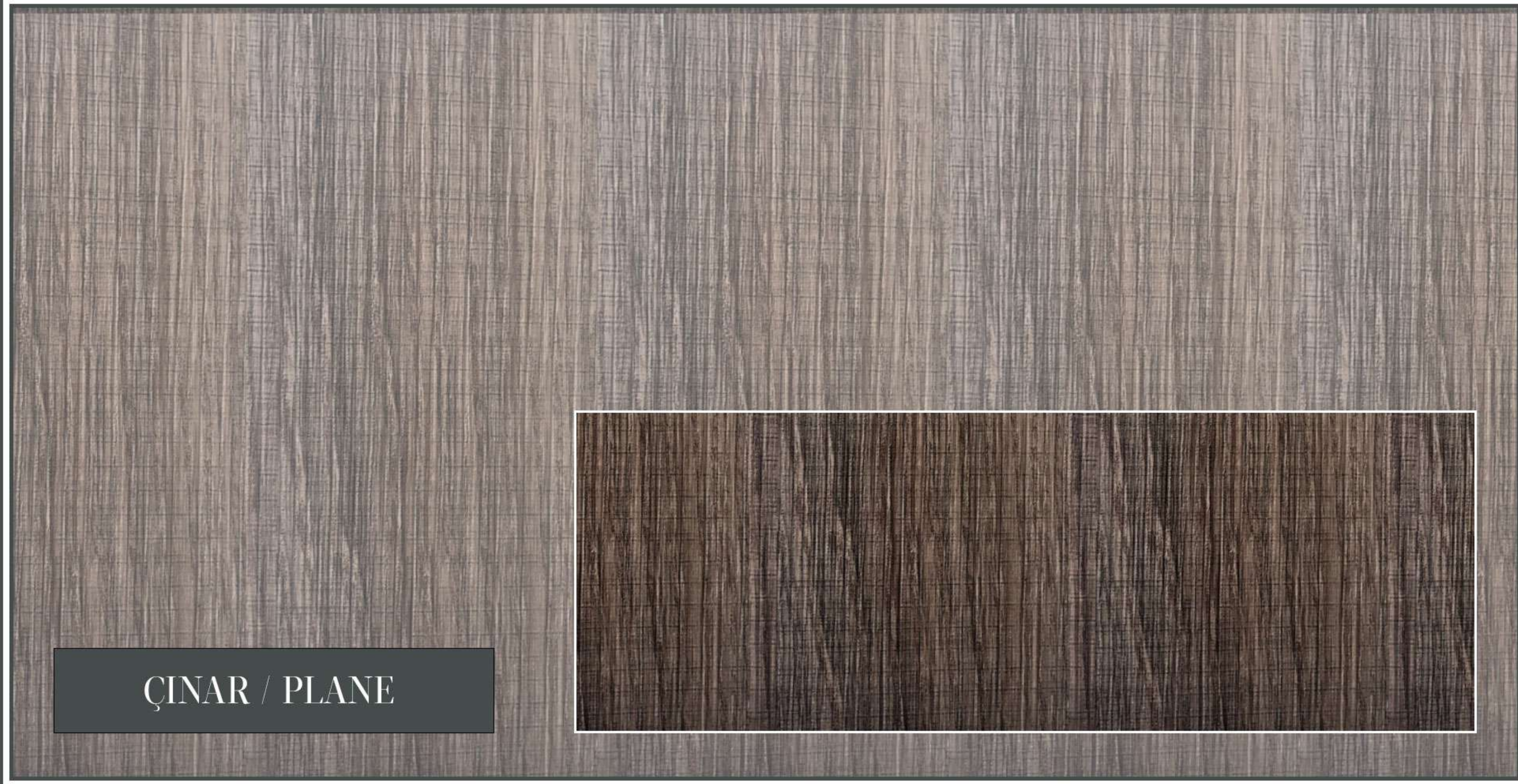

ÇINAR / PLANE

Polimerik
Lamine Ağaç Kaplama

ADEN Line



Bu katalog yalnızca alıcının kullanımı içindir. Bütün bölümleri ve her hakkı Dortek'e aittir. Kataloğun tekrar basımı, kısmi dahi olsa şekillerinin kopyalanması, çizilmesi ve katalog tasarımının kopyalanması yasaktır. Bu katalogdaki teknik tanımlar, ölçüler ve çizimler bağlayıcı değildir. Dortek, her tür ölçü, kaplama, donanım ve aksesuar değiştirme hakkını saklı tutar. Tasarım aşamasında güncel detayların teyit edilmesi gerekir. Sipariş aşamasında, sadece Dortek güncel fiyat listesinde yer alan kod bilgileri değerlendirmeye alınır. Baskıda oluşabilecek hatalardan dolayı sorumluluk kabul edilmez.

Telif hakları Dortek Kapı San. ve Tic. A.Ş.'ye aittir. Tüm hakları saklıdır.

2021

A large, light-colored watermark of the DorteK logo is positioned on the left side of the page. The logo consists of the word "dorteK" in a serif font, with a stylized door handle icon to its right. The "TM" trademark symbol is located above the "K".

This catalog is only for the use of the buyer. All sections and rights belong to DorteK. It is strictly forbidden to reproduce, copy, draw the figures even partially and to copy the catalog's design. The technical specifications, measures and drawings shall not be binding. DorteK reserves the right to change any. During the ordering, the code details given in DorteK's current price list are considered. All deliveries are performed according to the sales conditions of DorteK. No responsibility is assumed for any mistake occurring in the printing.



DORTEK KAPI SAN. VE TİC. A.Ş.

Merdivenköy Mah. Yumurtacı Abdi
Bey Cd, Dikyol Sk. No:2 B Blok Kat:19,
34732 KADIKÖY / İSTANBUL

Ofis Telefon: +90 216 412 40 35

Fax: +90 216 412 27 72

Email: info@dortek.com.tr

Web: www.dortek.com.tr